

Thermo Scientific Dionex UltiMate 3000 Series

Diode Array Detectors
DAD-3000(RS) and MWD-3000(RS)

Operating Instructions
(Original Operating Instructions)



Revision: 1.4

Date: September 2013

© 2013 Thermo Fisher Scientific Inc.

Doc. No. 4820.8250



Declaration of Conformity

(Original Declaration of Conformity)

Product: Thermo Scientific Dionex UltiMate 3000 - Detector
Types: **DAD-3000** and **DAD-3000RS**
MWD-3000 and **MWD-3000RS**

Dionex Softron GmbH herewith declares conformity of the above products with the respective requirements of the following regulations:

- Low-Voltage Directive 2006/95/EC
- EMC Directive 2004/108/EC

The electrical safety of the products was evaluated based on the following standard:

- DIN EN 61010-1:2010
Safety requirements for electrical equipment for measurement, control and laboratory use, Part 1: General Requirements

The Electromagnetic Compatibility (EMC) of the products was evaluated based on the following standard:

- DIN EN 61326:2006
Electrical equipment for measurement, control and laboratory use
EMC Requirements

This declaration is issued for the manufacturer

Dionex Softron GmbH
Part of Thermo Fisher Scientific Inc.
Dornierstraße 4
D-82110 Germering

by the Managing Director, Rüdiger Obst, and
the Vice President HPLC, Fraser McLeod.

September 2, 2013

Table of Contents

1	Introduction.....	1
1.1	How to Use This Manual	1
1.2	Safety	3
1.2.1	Symbols on the Instrument and in the Manual	3
1.2.2	Safety Precautions	5
1.2.3	Consignes de Sécurité.....	9
1.3	Intended Use	13
1.4	Federal Communications Commission (FCC) Note.....	14
2	Overview.....	15
2.1	Unit Description.....	15
2.2	Operating Principle	16
2.3	Detector Configurations.....	18
2.4	Interior Components	19
2.5	Front Panel Elements	20
2.6	Rear Panel	21
2.6.1	Power Switch.....	21
2.6.2	Fuse Cartridge	21
2.6.3	USB Connector.....	22
2.6.4	Analog Outputs (optional).....	22
2.6.5	pH and Conductivity Monitor (optional).....	23
2.7	Fluid Connections	23
2.8	Flow Cells	24
2.9	Lamps.....	25
2.10	Leak Sensor.....	25
2.11	Chromeleon Software	26
2.11.1	System Requirements	26
2.11.2	Direct and Automated Control	27
2.12	System Wellness, Predictive Performance, and Diagnostics.....	28
3	Installation.....	29
3.1	Facility Requirements	29
3.2	Unpacking.....	29
3.3	Positioning the Detector in the UltiMate 3000 System	31
3.4	Connecting the Detector	33
3.4.1	General Information	33
3.4.2	Connecting the USB Cable.....	33
3.4.3	Connecting the Power Cord.....	33
3.5	Setting Up the Detector in Chromeleon.....	34
3.5.1	Loading the USB Driver for the Detector	34
3.5.2	Installing the Detector	36
3.5.3	Configuring the Detector	37
3.6	Setting Up the Detector in DCMSLink.....	41

4	Preparation for Operation (Startup)	43
4.1	Overview of Actions	43
4.2	General Precautions for Connecting Capillaries	44
4.3	Connecting the Drain System	45
4.4	Equilibrating the System	45
4.5	General Guidelines for Detector Operation	47
4.5.1	Wavelength	47
4.5.2	Mobile Phases	47
4.5.3	Mobile Phase Delivery System	48
4.5.4	Flow Cell	48
4.5.5	Lamps	48
5	Operation and Maintenance	49
5.1	Power-Up	49
5.2	Status Screen	50
5.3	Chromeleon Software	51
5.3.1	Connecting to Chromeleon	51
5.3.2	Direct Control	52
5.3.3	Automated Control	55
5.4	Display Screens (Function Keys and Menus)	57
5.4.1	Showing the Function Keys	57
5.4.2	Detector Menus	58
5.5	Operational Settings	65
5.5.1	Turning on the Lamps	65
5.5.2	Setting the Wavelength for UV_VIS channels	66
5.5.3	Setting the 3D Wavelength Range (DAD-3000(RS) only)	66
5.5.4	Starting and Stopping Data Acquisition	67
5.5.5	Detecting Liquid Leaks in the Detector	68
5.5.6	Adjusting the Screen Brightness or Contrast	68
5.6	Special Functions in Chromeleon	69
5.6.1	Optimizing Detector Performance	69
5.6.2	SmartStartup and SmartShutdown	75
5.6.3	Predictive Performance	75
5.6.4	Recording the Lamp House Temperature	76
5.6.5	Detector Diagnostics	77
5.6.6	Operational Qualification and Performance Qualification	77
5.7	Shutting Down the Detector	78
5.8	Routine and Preventive Maintenance Intervals	80
6	Troubleshooting	81
6.1	Overview	81
6.2	Messages on the Detector Display	82
6.3	Diagnostics Tests in Chromeleon	85
6.3.1	Dark Current Test	85
6.3.2	Holmium Oxide Test	87
6.3.3	Intensity Test	87

6.3.4	Slit Test (DAD-3000RS and MWD-3000RS only).....	88
6.4	Operating Problems	89
7	Service.....	97
7.1	General Notes and Safety Precautions.....	97
7.2	Wavelength Verification.....	99
7.3	Lamps.....	101
7.3.1	Diagnostic Functions for the Lamps.....	102
7.3.2	Replacing the Deuterium Lamp.....	103
7.3.3	Replacing the Tungsten Lamp.....	106
7.4	Flow cell	108
7.4.1	Cleaning the Flow Cell.....	108
7.4.2	Exchanging the Flow Cell	109
7.5	Drying the Leak Sensor	115
7.6	Replacing the Main Power Fuses.....	116
7.7	Updating the Detector Firmware	117
8	Technical Information.....	119
9	Accessories, Consumables, and Spare Parts	121
9.1	Standard Accessories	121
9.2	Optional Accessories	122
9.3	Consumables and Spare Parts	124
10	Appendix.....	127
10.1	Common Mobile Phases	127
10.2	Declaration of Conformity for Holmium Oxide Filters.....	129
11	Index.....	131

1 Introduction

1.1 How to Use This Manual

The layout of this manual is designed to provide quick reference to the sections of interest to the reader. However, in order to obtain a full understanding of your Thermo Scientific™ Dionex™ detector, Thermo Fisher Scientific recommends that you review the manual thoroughly before beginning operation.

Almost all descriptions in the manual apply to the following variants of the diode array and multiple wavelength detectors in the UltiMate™ 3000 series:

- DAD-3000
- DAD-3000RS
- MWD-3000
- MWD-3000RS

The following conventions apply to the descriptions throughout this manual:

- The term "the detector" or "the device" is used throughout the manual. If some detail applies to only one version, the detector is identified by name.
- If not otherwise stated, the descriptions for the Viper™ capillary connections apply also to the nanoViper™ and possible other Viper capillary connections.
- The device configuration may vary. Therefore, not all descriptions necessarily apply to your particular module.
- The representation of a component in this manual may be slightly different from the real component. However, this does not influence the descriptions.
- The descriptions in this manual refer to firmware version 2.40 and Chromeleon™ 6.80 Service Release 13. If you want to operate the detector from Chromeleon 7, note the information on page 26.

This manual is provided "as is". Every effort has been made to supply complete and accurate information and all technical specifications have been developed with the utmost care. The information contained in this manual should not be construed as a commitment by Thermo Fisher Scientific. Thermo Fisher Scientific assumes no responsibility for any errors that may appear in this document that is believed to be complete and accurate at the time of publication and, in no event, shall Thermo Fisher Scientific be liable for incidental or consequential damages in connection with or arising from the use of this document. We appreciate your help in eliminating any errors that may appear in this document.

The information contained in this document is subject to change without notice.

All rights reserved, including those for photomechanical reproduction and storage on electronic media. No part of this publication may be copied or distributed, transmitted, transcribed, stored in a retrieval system, or transmitted into any human or computer language, in any form or by any means, electronic, mechanical, magnetic, manual, or otherwise, or disclosed to third parties without the express written permission of Thermo Fisher Scientific Inc.

Trademarks

Analyst is a registered trademark of AB Sciex.

Compass and Hystar are trademarks of Bruker Daltonics.

Empower is a trademark of Waters Corp.

MP35N is a registered trademark of SPS Technologies.

PEEK is a trademark of Victrex PLC.

Windows and Windows Vista are registered trademarks of Microsoft Corp.







All other trademarks are property of Thermo Fisher Scientific Inc. and its subsidiaries.

1.2 Safety





The CE Mark label and cTUVus Mark safety label on the instrument indicate that the detector is compliant with the related standards.

1.2.1 Symbols on the Instrument and in the Manual

The table shows the symbols used on the instrument:

Symbol	Description
	Alternating current—Courant alternatif
	Power supply is on (-)—L'instrument est mis sous tension (-) and Power supply is off (O)—L'instrument est mis hors tension (O)
	Surface becomes hot during operation—La surface devient chaude lors du fonctionnement.
	The deuterium lamp emits UV radiation that is harmful to the eyes and skin. Therefore, avoid looking directly into the light source. Operate the lamp only in the detector with the lamp cover installed and never outside the instrument.
	Refer to the Operating Instructions to prevent risk of harm to the operator and to protect the instrument against damage. Référez-vous à ce manuel pour éviter tout risque de blessure à l'opérateur et/ou protéger l'instrument contre tout dommage.
	Label according to the "Measures for Administration of the Pollution Control of Electronic Information Products" (China RoHS) guideline Étiquette "Measures for Administration of the Pollution Control of Electronic Information Products" (China RoHS)
	WEEE (Waste Electrical and Electronic Equipment) label—For more information, see the WEEE Information section in the "Installation and Qualification Documents for Chromatography Instruments" binder. Étiquette DEEE (Déchets d'Equipements Electriques et Electroniques) — Pour plus d'informations, référez-vous au chapitre WEEE Information dans le classeur "Installation and Qualification Documents for Chromatography Instruments".

At various points throughout the manual, the following symbols indicate messages of particular importance:

-  **Tip:** Indicates general information, as well as information intended to optimize the performance of the device.
-  **Important:** Indicates that failure to take note of the accompanying information could cause wrong results or may result in damage to the device.
-  **Important:** Indique que ne pas tenir compte de l'information jointe peut conduire à de faux résultat ou endommager l'instrument.
-  **Warning:** Indicates that failure to take note of the accompanying information may result in personal injury.
-  **Avertissement:** Indique que ne pas tenir compte de l'information jointe peut entraîner des blessures corporelles.

1.2.2 Safety Precautions

When working with analytical instrumentation, you must know the potential hazards of using chemical solvents.

 **Tip:** Before initial operation of the detector, make yourself familiar with the contents of this manual.

For the safety precautions in French, see page 9.

 **Warning:** All users of the device must observe the following safety precautions and all additional safety precautions in this manual to avoid the possibility of personal injury or damage to the device when operating the device or carrying out any maintenance or service procedures.

Observe any warning labels on the device and see the related sections in these *Operating Instructions*.

- **Protective equipment**

When performing any work on or near the HPLC system, wear personal protective equipment (protective clothing, safety gloves, safety glasses) as required by the hazard of the mobile phase and sample. For information about the proper handling of particular substance and for advice on specific hazards, refer to material safety data sheet for the substance you are using. Observe the guidelines of Good Laboratory Practice (GLP).

An eyewash facility and a sink should be close to the device. If any substance splashes on the eyes or skin, wash the affected area and seek medical attention.

- **Hazardous substances**

Many organic solvents, mobile phases, and samples are harmful to health. Be sure that you know the toxic and infectious properties of all substances that you are using. You may not know the toxic or infectious properties of many substances that you are using. If you have any doubt about a substance, treat it as if it contains a potentially harmful substance. For advice on the proper handling of a particular substance, refer to the Safety Data Sheet (SDS) of the manufacturer. Observe the guidelines of Good Laboratory Practice (GLP).

Dispose of waste substance in an environmentally safe manner that is consistent with all local regulations. Do not allow flammable, toxic, and/or infectious substances to accumulate. Follow a regulated, approved waste disposal program. Never dispose of flammable, toxic, and/or infectious substances through the municipal sewage system.

- **Hazardous gases**

Install the HPLC system in a well-ventilated laboratory. If the mobile phase or sample includes volatile or flammable solvents, do not allow them to enter the workspace. If the mobile phase or sample includes volatile or flammable solvents, avoid open flames and sparks.

- **Electrostatic discharge**

Discharge of electrostatic energy may lead to sparking and can constitute a fire hazard. Keep in mind that liquid flowing through capillaries can generate static electricity. This effect is particularly pronounced in insulating capillaries and with non-conductive solvents (for example, pure acetonitrile).

Take appropriate measures to prevent the generation of static electricity near the HPLC system. For example, make sure that the air humidity level in the laboratory is sufficiently high and provide proper ventilation, wear anti-static clothing or shoes, prevent accumulation of air bubbles in waste lines, and use grounded waste containers. Use only non-conductive capillaries to direct solvents into the waste container. With electrically conductive capillaries, make sure that they are properly grounded.

- **Self-ignition of solvents**

Do not use solvents for which the self-ignition temperature is below 150 °C. In case of leakage, these solvents may self-ignite on a hot surface.

- **Capillaries, capillary connections, open connections**

- ◆ Capillaries, especially non-metallic capillaries may burst, slip out of their fittings or may not be screwed in. This may result in substances spraying out of the open connections.
- ◆ In an UltiMate 3000 system, some components are made of PEEK™. This polymer has superb chemical resistance to most organic solvents. However, it tends to swell when in contact with trichloromethane (CHCl₃), dimethyl sulfoxide (DMSO), or tetrahydrofuran (THF). In addition, it is attacked by concentrated acids, such as, sulfuric acid and nitric acid or a mixture of hexane, ethyl acetate, and methanol. In both cases, capillaries may start leaking or they can burst. Swelling or attack by concentrated acids is not a problem with brief flushing procedures.
- ◆ Do not use tubing that is stressed, bent, kinked, or damaged.
- ◆ Capillary connections can be contaminated by harmful substances or harmful substances can escape from open connections.
- ◆ Some capillaries are made of MP35N[®], a nickel-cobalt based alloy. Individuals with sensitivity to nickel/cobalt may show an allergic reaction from skin contact.
- ◆ Always wear safety glasses when handling fused silica tubing, for example, during installation or when cutting capillaries to the length.

- **Hot surfaces**

- ◆ During operation, the lamps and the surrounding parts become extremely hot and remain so for some time after the detector is turned off. To avoid possible injury, allow sufficient time for the lamp to cool before performing any maintenance or repair work.
- ◆ Flow cells can become extremely hot during operation. To avoid possible injury, allow sufficient time for the flow cell to cool down before replacing the cell.

- **UV radiation**

- ◆ The deuterium lamp emits UV radiation that is harmful to the eyes and skin. The deuterium lamp can emit UV radiation from the rear side of the lamp (side of the connection wires) when it is installed in the detector. Therefore, avoid looking directly into the light source. Operate the lamp only in the detector with the lamp cover installed and never outside the instrument. Always turn off the detector and disconnect the power cord from its source before exchanging the deuterium or tungsten lamp.

To avoid possible injury to the skin, do not reach inside the lamp house. Insert only the tungsten lamp and no other parts into the lamp house of the detector.

- ◆ When the flow cell is removed and the lamps are turned on, monochromatic light emits in the flow cell opening from the opening on the right of the flow cell. The UV radiation is harmful to the eyes and skin. To avoid possible damage to the eyes and skin, turn off the detector before replaing the flow cell or wear UV glasses and appropriate protective clothing.

To avoid possible injury to the skin, do not reach inside the flow cell opening. Insert only the flow cell and no other parts into the flow cell opening of the detector.

- Disconnect the module from all power sources before removing any panels. Disconnect the detector from all power sources before removing the panels. The enclosure must be opened only by Thermo Fisher Scientific service personnel.
- Always replace blown fuses with original spare part fuses authorized by Thermo Fisher Scientific.
- Replace faulty communication cables.
- Replace faulty power cords. Never use a power cord other than the power cords provided for the device.
- Use only the original spare parts and accessories authorized for the device by Thermo Fisher Scientific.
- When lifting or moving the detector, always lift the unit by the bottom sides or sides. Do not lift the detector by the front panel door. This may damage the door.
- The open front panel door is not designed to carry weight. Do not place any heavy objects on the open front panel door. This may damage the door.
- After operation, rinse out buffers and solutions that form peroxides.
- Before switching from buffer to organic solution, rinse the analytical system thoroughly with deionized or HPLC grade water.
- When switching to another solvent, ensure that the new solvent is miscible with the one contained in the HPLC system. If the solvents are not miscible, the system can be damaged, for example, by flocculation.
- If a leak occurs, turn off the instrument and remedy the situation immediately.

- Use only standard solvents (HPLC grade) and buffers that are compatible with all parts that may be exposed to solvents
- Before interrupting operation for several days or more or when preparing the detector for transport, observe the precautions for shutting down the detector (→ page 78).
- Do not use the detector in ways other than those described in these *Operating Instructions*.
- Keep the operating instructions near the device to be available for quick reference.

1.2.3 Consignes de Sécurité

Si vous utilisez d'instrumentation analytique, vous devez connaître les risques d'utilisation de produit chimiques.

 **Veillez noter :** Avant de commencer à utiliser l'instrument, assurez-vous que vous vous êtes familiarisés avec le contenu de ce manuel.

 **Avertissement:** Toutes les personnes utilisant l'instrument doivent observer les consignes de sécurité suivantes et dans les autres chapitres de ce manuel pour éviter une mise en danger de sa personne ou de dommage à l'instrument pendant l'utilisation et des opérations de maintenance ou service de l'instrument.

Observez les étiquettes d'avertissement sur l'instrument et référez-vous aux sections correspondantes dans ce mode d'emploi.

- **Equipment de protection**

Pour tous les travaux sur le système HPLC ou à proximité, portez l'équipement de protection personnel (vêtements de protection, gant de sécurité, lunettes de protection) qui correspond aux risque découlant de la phase mobile et/ou de l'échantillon. Pour les informations sur la manipulation correcte des composés et des recommandations pour les situations de risque spécifiques, veuillez consulter la fiche de données de sécurité des substances que vous utilisez. Veuillez respecter des directives des Bonnes Pratiques de Laboratoire (BPL).

Une installation permettant de se laver les yeux ainsi qu'un lavabo doivent se trouver à proximité du système. Si une substance, quelle qu'elle soit, entre en contact avec vos yeux ou votre peau, rincez abondamment la zone affectée à l'eau, puis.

- **Substances dangereuses**

De nombreux solvants organiques, phases mobiles et échantillons sont nuisibles à la santé. Informez-vous de propriétés toxicologiques et infectieuses de toutes les substances que vous utilisez. Les propriétés toxicologiques et infectieuses de nombreuses substances peuvent être mal connues. Au moindre doute concernant une substance, traitez-la comme s'il contenait une substance potentiellement dangereuse. Pour des instructions comment utiliser correctement des composés particuliers, veuillez consulter à la fiche de données des sécurités du fabricant respectif. Veuillez respecter des directives des Bonnes Pratiques de Laboratoire (BPL).

Débarrassez-vous de tous les déchets de substances de manière écologique, conformément à la réglementation en vigueur au niveau local. Empêchez impérativement l'accumulation de solvants inflammables, toxiques et/ou infectieux. Suivez un programme d'élimination des déchets règlementé et approuvé. Ne jetez jamais de solvants inflammables, toxiques et/ou infectieux dans le système municipal d'évacuation des eaux usées.

- **Gaz dangereux**

Installez le système HPLC dans un laboratoire bien ventilé. Si la phase mobile ou l'échantillon contient des solvants volatils ou inflammables, vous devez assurer qu'ils ne pénètrent dans l'espace de travail. Si la phase mobile ou l'échantillon contient des solvants volatils ou inflammables, évitez les flammes nues et les sources d'étincelles à proximité.

- **Décharge électrostatique**

Décharge électrostatique peut provoquer la formation d'étincelles et peut présenter un risque d'incendie. Veuillez noter que des solvants fluides dans les capillaires peuvent se charger automatiquement. Cet effet se peut produire particulièrement forte dans les capillaires isolants et avec des solvants non-conducteurs (par exemple, l'acetonitrile pur).

Prenez des mesures appropriées pour éviter les charges électrostatiques à proximité du système HPLC. Par exemple, s'assurez qu'il y a une humidité de l'air suffisante et une ventilation adéquate dans la laboratoire, portez des vêtements ou équipement de protection antistatique, évitez l'accumulation de bulles d'air dans les lignes de déchets et utilisez des réservoirs à déchets mis à la terre.

Utilisez uniquement des capillaires non-conducteurs pour diriger solvants au réservoir de déchets. Capillaires électriquement conducteur devrait être mis à la terre.

- **Inflammation spontanée des solvants**

N'utilisez aucun solvants avec une température d'auto-inflammabilité inférieure à 150° C. Si une fuite se produit, ces solvants peuvent s'auto-enflammer au contact d'une surface chaude.

- **Capillaires, connecteur capillaires, connexions ouvertes**

- ◆ Des capillaires, en particulier les capillaires non-métalliques, pourraient fendre ou glisser des connecteurs ou ne peuvent pas être vissés. Ceci peut en résulter aussi que des substances pourraient jaillir des connexions ouvertes.

- ◆ Dans un système UltiMate 3000, certaines composantes sont en PEEK. Bien que ce polymère présente une excellente résistance chimique à la plupart des solvants organiques, il a tendance à gonfler lorsqu'il est en contact prolongé avec du chloroforme (CHCl₃), du diméthyle sulfoxyde (DMSO) ou du tétrahydrofurane (THF). De plus, il est attaqué par des acides concentrés tels que l'acide sulfurique et l'acide nitrique ou d'un composé du hexane, éthyle acétate et méthanol. Ceci peut causer des capillaires de fuite ou risquer des capillaires d'éclater. Ces acides peuvent cependant être utilisés dans le cadre de procédures de nettoyage, à condition que l'exposition soit brève.

- ◆ N'utilisez pas de capillaires écrasés, pliés, abimés ou endommagés.

- ◆ Les connecteurs capillaires pour pourrait être contaminé par des substances dangereuses ou des substances dangereuses pourrait sortir des connexions ouvertes.

- ◆ Dans un système UltiMate 3000 Bio RS, certains capillaires du système Viper sont faits d'alliage de nickel-cobalt MP35N. Contact avec la peau peut provoquer une réaction chez les personnes qui sont sensibles au nickel/cobalt.

- ◆ Portez des lunettes de protection lorsque vous manipulez des capillaires en silice fondue (pendant l'installation, découpe, etc.).
- **Surface chaude**
 - ◆ Lampes et les parties environnantes deviennent très chaudes pendant le fonctionnement. Pour éviter toute blessure, vous attendez après mise hors tension jusqu'à ce que les lampes soient refroidies. Commencer seulement alors les travaux d'entretien.
 - ◆ Les cellules de mesure peuvent devenir très chaudes pendant le fonctionnement. Pour éviter toute blessure, vous attendez jusqu'à ce que la cellule est refroidi avant de remplacer le capteur.
- **Rayonnement UV**
 - ◆ La lampe au deutérium émet des rayonnements UV nocifs pour les yeux et la peau. Par conséquent, évitez de regarder directement dans la source de lumière. La lampe au deutérium peut émettre des rayonnements UV de l'arrière de la lampe (côté avec les câbles de raccordement) lorsqu'il est installé dans le détecteur. Exploiter la lampe uniquement dans le détecteur avec le coffret de la lampe installé et jamais à l'extérieur de l'instrument. Arrêtez le détecteur. Assurez-vous de bien débrancher le cordon d'alimentation de la source secteur, si vous voulez remplacer la lampe au deutérium et la lampe au tungstène.
Pour éviter d'éventuelles blessures sur la peau, ne touchez pas à l'intérieur du le logement de la lampe au tungstène. Insérez seulement la lampe au tungstène dans le logement de la lampe. N'insérez aucune autre pièce.
 - ◆ Lorsque la cellule est retirée et les lampes sont allumées, le faisceau de lumière monochromatique émis par l'optique devient visible dans le logement de la cellule par l'ouverture sur la droite de la cellule. Le rayonnement UV peut causer des dommages aux yeux et peau. Afin d'éviter de possibles dommages aux yeux et peau, coupez l'alimentation électrique du détecteur, ou bien portez des lunettes de protection contre les UV et vêtements de protection.
Pour éviter d'éventuelles blessures sur la peau, ne touchez pas à l'intérieur du le logement de la cellule. Insérez seulement la cellule dans le logement de la cellule. N'insérez aucune autre pièce.
- Quand les capots de protection de l'appareil sont démontés, vous êtes exposés à des connexions électriques sous haute tension deviennent accessibles. Débranchez l'instrument de toute source d'alimentation électrique avant de retirer les capots. Ne démontez les capots de protection que si cela est explicitement demandé au cours de ces instructions. Les capots de protection devraient être démontés uniquement par le personnel de service de Thermo Fisher Scientific.
- Remplacez toujours les fusibles grillés par des fusibles de rechange autorisés par Thermo Fisher Scientific.
- Remplacez les câbles de communication défectueux.

- Remplacez les cordons d'alimentation électrique défectueux. Utilisez uniquement les cordons d'alimentation électrique spécifique à l'instrument.
- Utilisez seulement des pièces de rechange originales et des accessoires autorisés par Thermo Fisher Scientific.
- Réglez toujours une limite de pression minimum pour le système HPLC. Ceci prévient les dommages résultant de fuites ou du fonctionnement à sec de la pompe.
- Lorsque vous soulevez ou l'instrument, tenez-le toujours par le dessous ou par les côtés de l'unité. Soulever l'instrument par la partie avant inférieure ou par le panneau avant peut endommager la porte.
- Ne placez aucun objet lourd sur la porte ouverte du panneau avant. Ceci pourrait endommager la porte.
- Après utilisation, purgez le système des tampons et des susceptibles de former des peroxydes.
- Lorsque vous passez d'une solution saline à un solvant organique, effectuez un rinçage intermédiaire du système HPLC à l'eau dé-ionisée ou qualité HPLC.
- Lorsque vous passez à un autre solvant, assurez-vous que le nouveau solvant soit miscible avec celui qui se trouve dans le système HPLC. Dans le cas contraire, le système HPLC peut être endommagé; par exemple, par des floculations!
- Si une fuite se produit, arrêtez immédiatement l'instrument, stoppez le débit de la pompe et remédiez au problème.
- Utilisez uniquement des solvants (qualité HPLC) et des solutions salines compatibles avec les matériaux exposés phase mobiles.
- Avant d'interrompre le fonctionnement pendant plusieurs jours ou plus, observez les précautions figurant en page 78.
- De nombreux solvants organiques et solutions salines sont toxiques. Informez-vous des propriétés toxicologiques de toutes les phases mobiles que vous utilisez.
- N'utilisez pas l'instrument de manière autre que celles décrites dans ce manuel.
- Conservez ce manuel à proximité de l'instrument pour pouvoir le consulter facilement.

1.3 Intended Use

For Research Use Only. Not for use in diagnostic procedures. The device is designed to be operated only by qualified and authorized personnel. All users must know the hazards presented by the device and the used substances.

The detector is designed for laboratory research use in high-performance liquid chromatography (HPLC) or ultra-high performance liquid chromatography (UHPLC) applications. It is part of the UltiMate 3000 system, but can be used also with other HPLC systems if adequate control inputs and outputs are available. A PC with a USB 2.0 port is required.

The detector can be controlled by the Chromeleon Chromatography Management System. Being part of the UltiMate 3000 system, the detector can also be operated with other data systems, such as

- Xcalibur™, Compass™/HyStar™, or Analyst®. Installation of the DCMS^{Link} (Thermo Scientific Dionex Chromatography Mass Spectrometry Link) software is required in addition to the installation of the data system.
- Empower™. Installation of the Thermo Scientific Dionex Instrument Integration Software is required in addition to the installation of the data system.

For more information, contact the Thermo Fisher Scientific sales organization for Dionex HPLC Products.

Observe the following:

- Note that the detector may be operated only with accessories and spare parts recommended by Thermo Fisher Scientific (→ page 121) and within its technical specifications (→ page 119).
- Use only standard solvents of at least HPLC grade or better LC-MS grade (0.2 µm, filtered), and buffers that are compatible with the flow path materials. Note the special properties of the solvents, such as the viscosity, boiling point, and UV absorption (UV/VIS detector).
- Buffer concentration: Typically up to 1 mol/L (steel flow cells: < 0.1 mol/L chloride ions).
- Also observe the information about the solvent compatibility and buffer concentrations of the other UltiMate 3000 system modules. For more information, refer to the *Operating Instructions* for the modules.

If there is any question regarding appropriate usage, contact Thermo Fisher Scientific before proceeding.



Warning:

If the device is used in a manner not specified by Thermo Fisher Scientific, the protection provided by the device could be impaired. Thermo Fisher Scientific assumes no responsibility and will not be liable for operator injury and/or instrument damage. Whenever it is likely that the protection is impaired, the instrument must be disconnected from all power sources and be secured against any intended operation.



Avertissement:

Si l'instrument est utilisé de façon non spécifiée par Thermo Fisher Scientific, la protection prévue par l'instrument pourrait être altérée. Thermo Fisher Scientific n'assume aucune responsabilité et ne sera pas responsable des blessures de l'opérateur et/ou des dommages de l'instrument. Si la protection de l'instrument n'est pas garanti à tout moment, débranchez l'instrument de toutes les sources d'alimentation électrique et assurez-vous que l'instrument n'est pas utilisé involontairement.

1.4 Federal Communications Commission (FCC) Note

This equipment has been tested and found to comply with the limits for a Class A digital device, pursuant to part 15 of the U.S. FCC Rules. These limits are designed to provide reasonable protection against harmful interference when the equipment is operated in a commercial environment. This equipment generates, uses, and can radiate radio frequency energy and, if not installed and used in accordance with the instruction manual, may cause harmful interference to radio communications. Operation of this equipment in a residential area is likely to cause harmful interference, in which case the user will be required to correct the interference at his expense.

2 Overview

2.1 Unit Description

The detector is a high-quality instrument designed for HPLC analysis as part of the UltiMate 3000 system.

- Two different light sources, a deuterium lamp for ultraviolet detection and a tungsten lamp for visible and near-infrared detection, provide a wavelength detection range from 190 nm to 800 nm. For more information about possible detector configurations, see page 18.
- The detector can collect up to eight single wavelengths (2D data) without being required to collect 3D data.
- In addition, the DAD-3000(RS) can be used to record 3D fields (spectra). Collecting all wavelengths simultaneously makes peak purity analysis and spectral library search for positive peak identification possible, among other things.
- To suppress the higher-order radiation typical of grating spectrometers, the detector is equipped with an optical filter.
- Variable slit width in the MWD-3000RS and DAD-3000RS detectors for optimizing baseline noise and optical resolution.
- The wavelength accuracy can be verified via the built-in holmium oxide filter. For information about the declaration of conformity for the holmium oxide filter, see section 10.2 (→ page 129).
- Flow cells are available for different fields of applications (→ page 24).
- Controlling the detector by Chromeleon provides a high degree of system integration, as well as maximum analysis efficiency due to comprehensive data analysis and evaluation features in Chromeleon.
- Various safety and monitoring features are provided for optimum system performance and reliability (→ page 28).
- All parts that may be exposed to solvents are made of materials that provide optimum resistance to the most commonly used solvents and buffer solutions in HPLC.

2.2 Operating Principle

Photometric detection is based upon the absorption of monochromatic light. The degree of absorption depends on the sample molecule, its concentration, the light's path length in the sample, and the measurement wavelength.

The definition of absorbance is Lambert-Beer's Law. Absorbance is dimensionless:

$$A = \epsilon cl = \log\left(\frac{I_{so}}{I_s}\right) \left[-\log\left(\frac{I_{ro}}{I_r}\right) \right]$$

where:

ϵ	Molar excitation coefficient of the analyte ($L \cdot \text{mol}^{-1} \cdot \text{cm}^{-1}$)
c	Concentration (mol/L)
l	Cell path length (cm)
I_r	Light intensity at the reference wavelength
I_s	Light intensity at the measured wavelength
I_{ro}	Light intensity at the reference wavelength with autozero
I_{so}	Light intensity at the measured wavelength with autozero

UV-Vis spectroscopy allows you to detect the chromophores of analyte molecules directly in the sample or to generate them indirectly by derivatization. For a list of the UV absorbance wavelengths of common chromophores, see section 10 (→ page 127).

Fig. 1 is a schematic of the optical system (→ page 17). Light from the tungsten lamp (no. 1) is focused by a lens (no. 2) through an opening in the internal structure of the deuterium lamp (no. 3). Light from the tungsten and deuterium lamps is then focused by the achromat (no. 4) through the flow cell (no. 5). After exiting the cell, the light passes through a lens (no. 6) and is focused into the slit (no. 8). A motor is used to move the filter paddle (holmium oxide filter, dark position) into this part of the light path. The light then passes through the slit to the grating (no. 9), where it is diffracted into the component wavelengths. Measurement of the light occurs at the photodiode array (no. 10). Each diode measures a narrow portion of the spectrum. A spectrum is obtained by measuring the light intensity of each diode and reporting the results over the selected wavelength range.

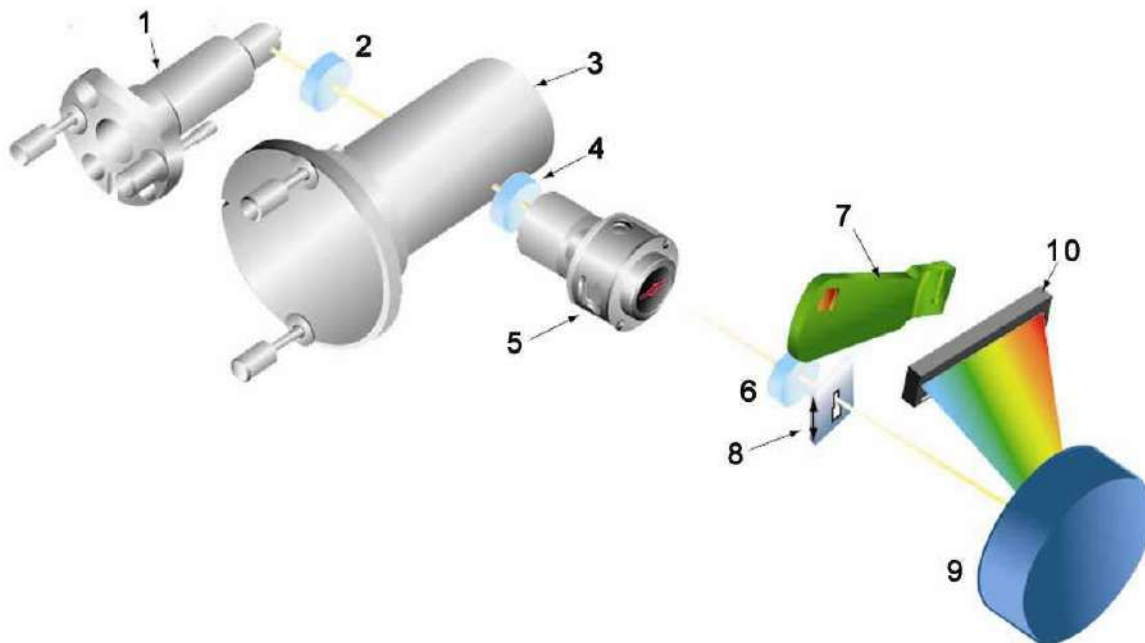

Fig. 1: Optics setup

No.	Component	Description
1	Tungsten lamp	Light source for the visible and near-infrared wavelengths (345 nm - 800 nm)
2	Lens (VIS)	Focuses the light from the tungsten lamp to the through hole (aperture) of the deuterium lamp.
3	Deuterium lamp	Light source for the UV wavelengths (190 nm - 350 (670) nm)
4	Achromat	Three-element lens, receives the light from both lamps and focuses it so that the beam passes through the flow cell.
5	Flow cell	The eluent with the analyte travels through the flow cell. The measurement beam travels through the flow cell to the detector.
6	Lens	Receives the light beam from the flow cell and focuses it so that the beam passes through the slit.
7	Filter paddle	Carries the optical filter for verification of the wavelength accuracy.
8	Entrance slit	The width of the slit optimizes the optical resolution. With the MWD-3000RS and DAD-3000RS, the slit width can be varied.
9	Optical grating	Grating (490 l/mm) - Diffracts the light beam into its component wavelengths and directs the light onto the photodiode array.
10	Photodiode array	A series of 1024 photosensitive elements.

2.3 Detector Configurations

The detector is available in the following configurations:

Detector Description	Part no.
DAD-3000RS detector for measurements up to 200 Hz*	5082.0020
DAD-3000 detector for measurements up to 100 Hz.	5082.0010
MWD-3000RS: as DAD-3000RS, but without 3D data acquisition	5082.0040
MWD-3000: as DAD-3000, but without 3D data acquisition	5082.0030

*Only with Chromeleon 7.1 or later

2.4 Interior Components

The front panel door tilts downward to provide easy access to the inside front panel, for example, for maintenance and repair work.

⚠ Important: The open front panel door is not designed to carry weight. Do not place any objects on the open front panel door; this may damage the door.

⚠ Important: Ne placez aucun objet lourd sur la porte ouverte du panneau avant. Ceci pourrait endommager la porte.

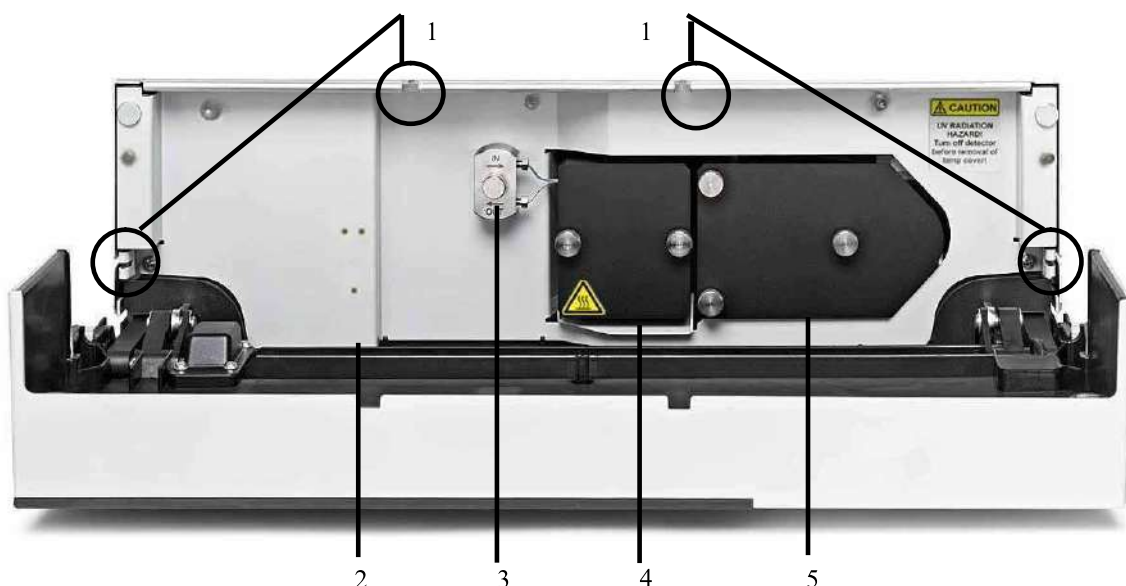

Fig. 2: Interior view from the front

No.	Description
1	Slots in the enclosure to route the flow cell capillaries to the outside (→ page 23) Two more slots with capillary guides are provided in the enclosure bottom.
2	Leak sensor (→ page 25)
3	Flow cell adapter block
4	Flow cell cover <i>No</i> flow cell (→ page 24) is installed when the detector is shipped. Before initial operation, install a flow cell.
5	Lamp cover A deuterium lamp and a tungsten lamp are installed behind the cover.

2.5 Front Panel Elements



Fig. 3: Front panel view

No.	Front Panel Element	Function
1	Display	Shows information about the detector: <ul style="list-style-type: none"> - General information upon power up (→ page 49) - Status screen, depending on the detector configuration (→ page 50) - Various function keys and menus (→ page 57) - Messages (→ page 81)
2	Standby button	Switches the detector to Standby mode (the LED is lighted). To cancel Standby mode and resume operation, press the Standby button again (the LED is not lighted). Note: To allow the detector to change the mode, press the Standby button for at least one second..
3	LEDs	
	Power	The LED is blue when the detector is on.
	Connected	The LED is green when the detector is controlled by Chromeleon.
	Status	The LED is red when an error has been detected, e.g. when the lamp has failed. In addition, the corresponding message appears on the front panel display (→ page 81). The LED is orange, for example, when the detector is booting. Otherwise, the LED is green.

2.6 Rear Panel

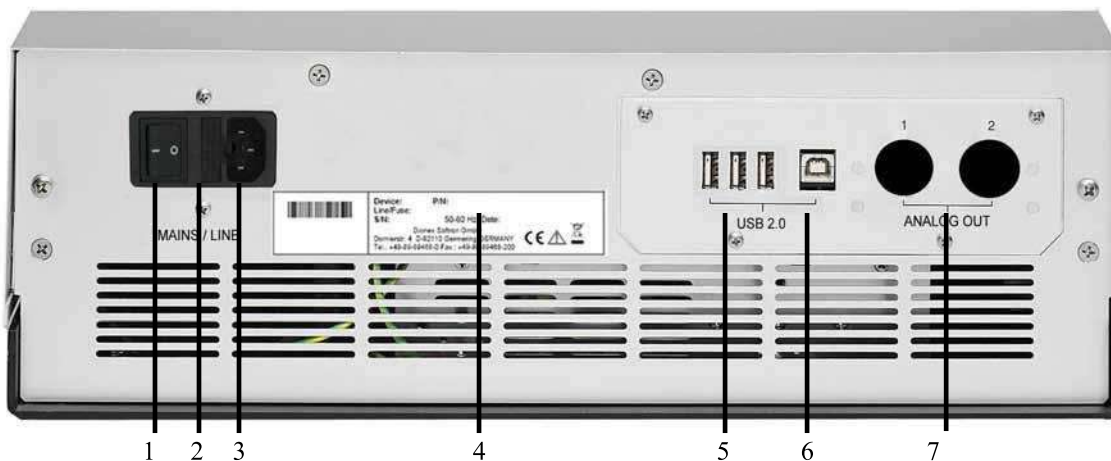

Fig. 4: Rear panel

No.	Description
1	Power switch (→ page 21)
2	Fuse cartridge (→ page 21)
3	Main power receptacle (→ page 33)
4	Type label
5	USB hub—3 additional ports for connection of one UltiMate 3000 device, or USB hub each (→ page 22)
6	USB 2.0 (Universal Serial Bus) port for connection to the Chromeleon computer (→ page 22)
7	Analog outputs (optional, → page 22)

2.6.1 Power Switch

The power switch on the rear panel is the main power switch for the detector. Turn on the power switch before initial operation of the detector and leave it on. For routine operation, leave the main power switch on. For routine on/off control, use the standby button on the front (→ page 20). Press and hold the button for about one second to allow the detector to change the mode. Turn off the main power switch when instructed to do so, for example, before performing a service procedure or when interrupting operation for longer periods (one week or more). Observe the precautions on page 78.

2.6.2 Fuse Cartridge

The fuse cartridge contains two slow-blow fuses rated at 2 A (5 x 20 mm). For information about how to change the fuses, see page 116.

2.6.3 USB Connector

The Chromeleon Chromatography Management System can use a USB connection to control the detector. Data is transferred digitally via the appropriate USB cable (→ page 33). The PC must be equipped with a USB2.0 port. Connect the detector directly to the PC. To ensure trouble-free operation, use only the cables shipped with the detector.

For information about how to connect the detector to the Chromeleon computer, see sections 3.4.1 and 3.4.2 (→ page 33).

2.6.4 Analog Outputs (optional)

If the optional DAC plug-in board (part no. 6082.0305) is installed, two analog outputs with a resolution of 20 bits each are provided. The outputs can be connected to additional evaluation devices. The analog output voltages are updated with the data rate selected in Chromeleon (Data Collection Rate), however, not exceeding a maximum data rate of 50 Hz.

i **Tip:** Operation of the analog outputs requires firmware version 1.07 (or later) and Chromeleon 6.80 SR7 (or later).

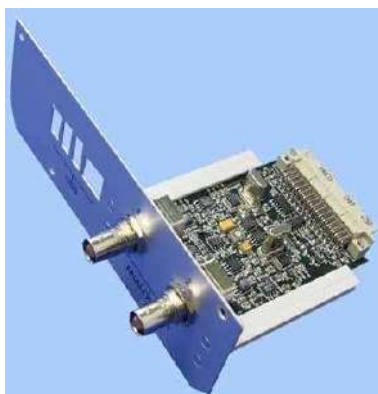

Fig. 5: DAC Board

2.6.5 pH and Conductivity Monitor (optional)

A pH and Conductivity Monitor (part no. 6082.2000) is available as an option, consisting of a suitable plug-in extension board for installation in the detector, a flow cell carrier with pre-mounted pH and conductivity flow cells, a hood, and a pH electrode.

For installation and configuration details, refer to the PCM-3000 manual.

i **Tip:** Operation of the pH and conductivity monitor requires firmware version 2.20 (or later) and Chromeleon 6.80 DU10b (or later).



Fig. 6: pH and Conductivity Monitor

2.7 Fluid Connections

The detector is designed to provide easy access to the fluid components. Tilt the front cover downward. At dedicated positions in the front part of the enclosure, six slots are provided for the capillaries: on the top and bottom of the enclosure (two slots each), and on the left and right side of the enclosure (one slot each) (→ Fig. 2, page 19).

Capillary guides on the bottom slots facilitate routing the capillaries to devices that are located underneath the detector in the UltiMate 3000 system stack.

When closing the front panel door, avoid bending the capillaries and make sure that they are routed to the outside through these slots.

i **Tip:** The volume between the column and the flow cell should be as low as possible to avoid peak broadening effects and the accompanying loss of chromatographic efficiency.

2.8 Flow Cells

The detector is shipped without a flow cell. Install a suitable flow cell first (→ page 109). To ensure optimum performance of the flow cells, observe the guidelines (→ page 48).

All flow cells are optimized for fast separations with no loss in chromatographic resolution. An identification chip is fitted to the flow cell in the factory. The chip stores unique information about the flow cell, including the cell type and serial number. When the flow cell is installed, a contact on the flow cell connects the chip to the detector electronics.

The analytical, semi-analytical, and semi-micro flow cells are equipped with a built-in heat exchanger. The heat exchanger helps adapt the temperature of the mobile phase to the flow cell temperature before the mobile phase enters the flow cell. Note that the volume of the heat exchanger and/or inlet capillary indicated in the table influences the retention times and peak widths.

The following flow cells are available for the detector:

Flow Cell Type	Flow Cell Material	Flow Cell Volume	Volume Heat Exchanger and / or Inlet Capillary	Part No.
Analytical, pressure limit: 120 bar	Stainless steel	13 µL	17 µL	6082.0100
Semi-micro, pressure limit: 120 bar	Stainless steel	2.5 µL	3.9 µL	6082.0300
Semi-analytical, pressure limit: 120 bar	Stainless steel	5 µL	3.9 µL	6082.0200
Analytical, pressure limit: 50 bar	PEEK	13 µL	34 µL	6082.0400
Semi-micro, pressure limit: 50 bar	PEEK	2.5 µL	3.9 µL	6082.0500
Semipreparative pressure limit: 100 bar	PEEK	0.7 µL	33 µL	6082.0600

2.9 Lamps

The following lamps are available for the detector:

- A deuterium lamp for UV wavelength detection.
- A tungsten lamp for visible and near-infrared wavelength detection

The table lists the lamps to use for various wavelength detection ranges.

Wavelengths Detected	Required lamp(s)
< 345.0 nm	Deuterium
> 670.0 nm	Tungsten
Between 345.0 and 670.0 nm	Deuterium or tungsten (or both)
< 345.0 nm and > 670.0 nm	Deuterium and tungsten

An identification chip is fitted to each lamp at the factory. The chip stores unique information about the lamp, including the lamp type, number of lamp starts, lamp age, and lamp intensity. This information provides an overview of the lamp status. When a lamp is installed, a contact on the lamp connects the chip to the detector electronics.

The lamps are installed behind the lamp house cover (→ Fig. 2, page 19) and easily accessible from the inside front panel. For more information, see section 7.3 (→ page 101).

2.10 Leak Sensor

A leak sensor (→ Fig. 2, page 19) is installed inside the detector. If liquid collects in the drip tray under the fluid connections, the leak sensor reports a leak, and the **Status LED** on the front panel door changes to red. In addition, a message appears on the front panel display and in the Chromeleon Audit Trail and a beep alerts you.

When the leak sensor reports a leak, eliminate the cause for the leakage and dry the leak sensor (→ page 115). If the sensor is not dry, the **Status LED** remains red. To remove the message from the display, select **Clear** on the navigation bar (→ page 60).

2.11 Chromeleon Software

i **Tip:** All software details in this manual refer to *Chromeleon 6.80*.

If you want to operate the detector from *Chromeleon 7*, refer to the following documents for information about how to perform the related processes in Chromeleon 7 (all documents are included in the Chromeleon 7 shipment):

- *Chromeleon 7 Help*—provides extensive information and comprehensive reference material for all aspects of the software.
- *Quick Start Guide*—describes the main elements of the user interface and guides you step-by-step through the most important workflows.
- *Reference Card*—provides a concise overview of the most important workflows.
- *Installation Guide*—provides basic information about module installation and configuration. For specific information about a certain module, refer to the Chromeleon 7 Instrument Configuration Manager Help.

Also note the following: Chromeleon 7 terminology is different from the terminology used in Chromeleon 6.80. For details, refer to the 'Glossary - Chromeleon 7,' which is available in the Documents folder of your Chromeleon 7 installation.

2.11.1 System Requirements

The detector can be controlled by the Chromeleon Chromatography Management System. To do so, an appropriate Chromeleon version and a **Timebase Class 1** Chromeleon license are required. In addition, a **3D Data Acquisition License** is required to control the DAD-3000 and DAD-3000RS.

A considerable amount of data is generated when recording 3D fields with a data collection rate of 100 Hz. Therefore, the Chromeleon PC should have the minimum performance requirements as listed in the table.

i **Tips:** It is *not* recommended to operate a DAD-3000(RS) at a data collection rate of 100 Hz on a network data source.

For details about the system requirements for operating the detector at 200 Hz from Chromeleon 7.1 or later, refer to the software Online Help.

For operation of a maximum of two UltiMate 3000 systems with *one DAD-3000(RS)* and a maximum of *one additional MWD-3000(RS)*:

Processor:	Pentium IV class, 2.4 GHz
RAM:	512 MB
Hard disk:	60 GB
Port:	USB 2.0 The USB 2.0 bandwidth consumption is approx. 12 % for each UltiMate 3000 system

For operation of a maximum of two UltiMate 3000 systems with *two DAD-3000(RS)*:

Processor:	Dual Core CPU, minimum 2 GHz
RAM:	1024 MB
Hard disk:	100 GB
Port:	USB 2.0 The USB 2.0 bandwidth consumption is approx. 12 % for each UltiMate 3000 system

2.11.2 Direct and Automated Control

Two modes of software control are available:

- **Direct Control**
With direct control, you select operating parameters and commands in the **Commands** (F8) dialog box. Direct commands are executed as soon as they are entered. For routine operation, most parameters and commands are available also on a control panel. For more information about direct control, see page 52.
- **Automated Control**
With automated control, you create a program (or PGM File). This is a list of control commands, executed in chronological order, for automated operation of the detector. Programs can be created automatically with the help of a software wizard or manually by editing an existing program. For more information about automatic control, see page 55.

2.12 System Wellness, Predictive Performance, and Diagnostics

System Wellness monitors the health of the detector. Therefore, the detector supports several performance and reliability features that can help you detect small problems before they turn into big ones:

- Internal monitoring of all mechanical operations
- Automatic self test upon power up
- Lamp type identification and documentation of the lamp properties
- Lamp operating hours and intensity monitoring (→ page 102)
- Flow cell identification and documentation of the flow cell type (→ page 64)
- Leak sensor (→ page 25)
- General information for detector diagnostics (→ page 64)

When an error is detected, the **Status** LED on the front panel is red and a message appears on the detector display (→ page 82).

Additional functions for estimating the lifetime of consumables and monitoring and recording service and (re)qualification information (= predictive performance; → page 75) are available. To check the performance of certain detector components and the overall performance of the instrument, Chromeleon 6.80 also supports diagnostic functions (→ page 77) for the detector.

3 Installation

3.1 Facility Requirements

The installation site must meet the following requirements:

- The main power switch and the main power receptacle are on the rear panel. Make sure that
 - ◆ Free and unrestricted access to the main power switch is ensured at all times.
 - ◆ The power cord of the device can be easily reached and disconnected from the power line at all times. Provide sufficient space behind the device to unplug the cable.
- Make sure that the installation site meets the power and environmental specifications listed in the Technical Information section (→ page 119).
- Install the detector in the laboratory on a stable surface that is free of vibrations.
- Make sure that the surface is resistant to solvents.
- The ambient temperature should be kept as constant as possible.
- Avoid locations with direct sunlight and high humidity.
- Allow sufficient clearance behind and to the sides of the detector for ventilation.

3.2 Unpacking

All electrical and mechanical components of the detector are carefully tested before the instrument is shipped from the factory. After unpacking, inspect the instrument for any signs of mechanical damage, which might have occurred during transit.

i **Tips:** Immediately report any shipping damage to both, the incoming carrier and Thermo Fisher Scientific. Shipping insurance will compensate for the damage only if reported immediately.

Keep the original shipping container and packing material. They provide excellent protection for the instrument in case of future transit. Shipping the unit in any other packaging automatically voids the product warranty.

1. Place the shipping container on the floor and remove the accessories kit and the power cord.

2. Grasp the detector by the sides. Slowly and carefully, pull the detector out of the shipping container and place it on a stable surface.

⚠ Important: To prevent the device from falling, grasp the device by the sides, and then lift the unit together with the foam spacers out of the shipping container. Do not lift the unit by the packaging material or the front panel.

⚠ Important: Afin d'empêcher l'instrument de tomber, saisissez-la par les côtés. Ne soulevez l'instrument à l'aide du matériau d'emballage ou par la porte du panneau avant.

3. Remove the foam spacers, and then remove the polythene packaging.
4. Loosen the shipping locks on the bottom of the detector. These locks secure the optics during shipment.

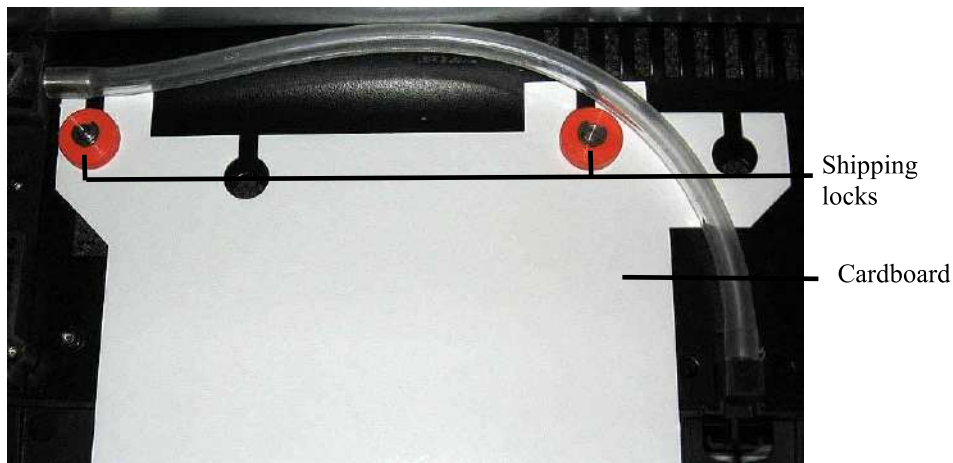

Fig. 7: Shipping locks securing the detector optics

5. Remove the cardboard with the notice about the shipping locks. Keep the cardboard together with the packaging. The shipping locks must *not* be fastened during operation.
6. Before connecting the detector to the power source, wait approximately 4 hours to allow the instrument to come to room temperature and to allow any condensation that might have occurred during shipping to evaporate. After 4 hours, check the detector; if condensation still exists, allow the detector to continue to warm up (without connecting it to the power source) until the condensation is completely gone.

3.3 Positioning the Detector in the UltiMate 3000 System

If the detector is part of an UltiMate 3000 system, for example for analytical HPLC applications, you should stack the individual modules, for example, as shown in Fig. 8 and interconnect them on the rear panel as shown in Fig. 9. However, the arrangement of the system modules depends on the application.

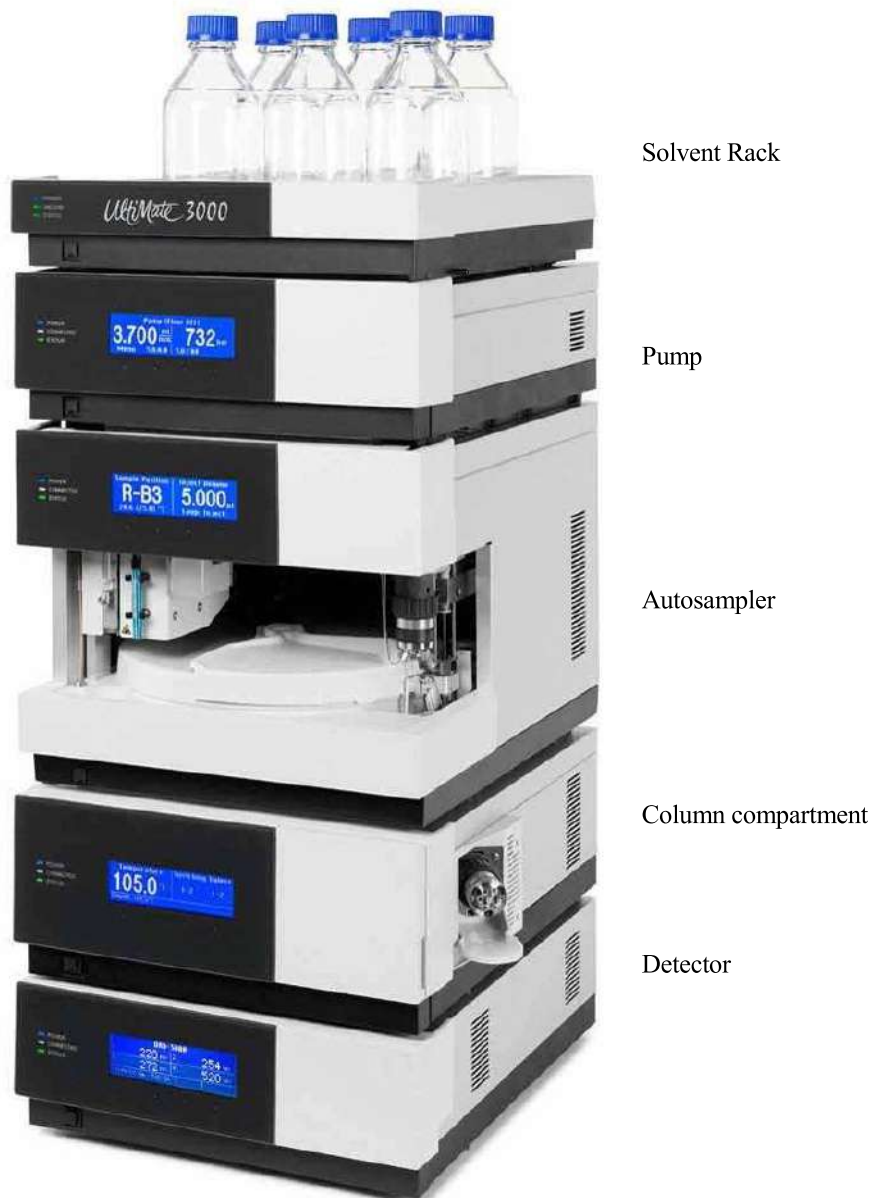

Fig. 8: Module arrangement for an UltiMate 3000 system (example)

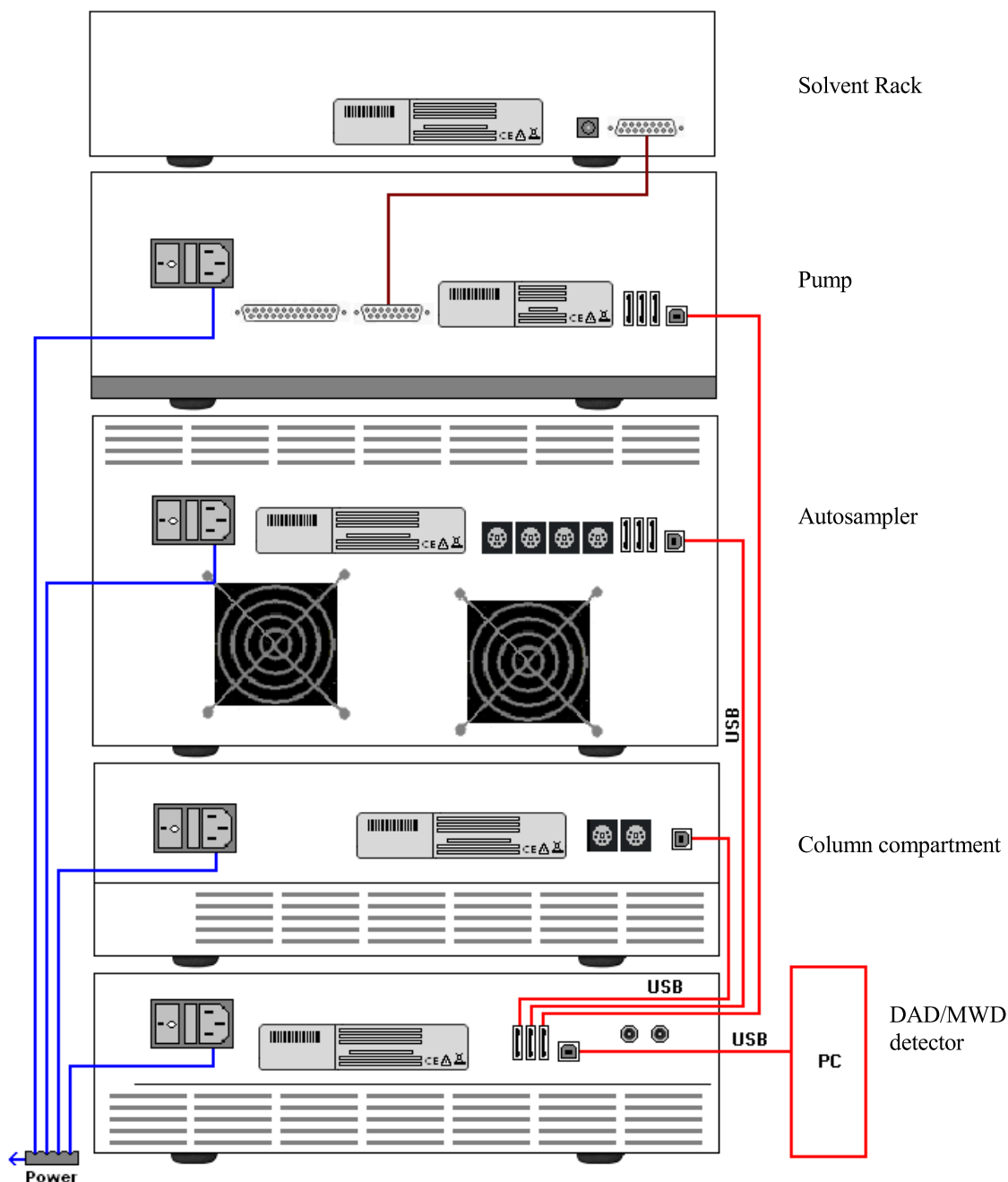

Fig. 9: Example for the rear panel connections on an UltiMate 3000 system

Apart from the Solvent Rack, all modules of the UltiMate 3000 system can be connected separately to the Chromeleon computer by using the USB port on the rear panel of the instrument. However, Thermo Fisher Scientific recommends interconnecting all modules, and then connecting the system to the Chromeleon computer with only one connection.

i Tip: It is not possible to use the USB hub on the autosampler for connection of the detector to the Chromeleon PC.

3.4 Connecting the Detector

3.4.1 General Information

Verify that Chromeleon is installed on the computer and that the license code is entered *before* you connect the detector to the USB port on the Chromeleon computer and turn on the detector power. Only if you install Chromeleon first, the detector is connected to the computer and the USB driver for the detector is automatically loaded. The Windows[®] operating system can detect the detector when the power is turned on.

3.4.2 Connecting the USB Cable

Directly connect the detector to the Chromeleon computer via the USB port on the rear panel (→ Fig 4, page 21). The PC must be equipped with a USB2.0 port. Note that it is not possible to connect the detector to a USB hub on the autosampler.

 **Tip:** The USB standard limits the USB cable length to 5 meters. Each USB device can be separated from the PC or next USB hub by no more than 5 meters

The following cables are available (provided in the accessories kit for the detector):

USB Cable	Part no.
USB cable, type A to type B, high speed USB 2.0 (cable length: 5 m)	6911.0002

3.4.3 Connecting the Power Cord

Use the power cord shipped with the detector to connect the instrument to the main power source. Connect the power cord from the main power receptacle on the rear panel. No manual adjustment is required to adapt the line voltage to local voltage requirements.

 **Warning:** Never use a power cord other than the power cords provided for the device.

Do not use multiple sockets or extension cords. Using defective multiple sockets or extension cords may cause personal injury or damage to the device.

 **Avertissement:** Utilisez uniquement les cordons d'alimentation électrique spécifique à l'instrument.

N'utilisez pas des blocs multiprise ou des câbles prolongateurs. Cela pourrait entraîner des blessures corporelles ou endommager l'instrument.

3.5 Setting Up the Detector in Chromeleon

This section provides brief instructions for setting up Chromeleon. For details, see the Chromeleon Help.

i **Tip:** When the detector is connected to the Chromeleon computer, verify that the Chromeleon software is installed *before* turning on the detector power for the first time. Only then, the USB driver for the detector is automatically loaded and the Windows operating system detects the detector when the power is turned on.

3.5.1 Loading the USB Driver for the Detector

1. Turn on the computer power, if it is not already on.
2. Under Windows Vista® (Windows® XP, Windows® 7, or Windows® Server 2008) log on as a
 - Local administrator if the computer is a local computer.
 - User with local computer administrator privileges if the computer is a network computer.
3. Open the **Chromeleon Server Monitor** program by double-clicking the Chromeleon Server Monitor icon  on the Windows taskbar.

If the Server Monitor icon is not on the taskbar, click Start on the taskbar, point to Programs (or All Programs, depending on the operating system), point to Chromeleon, and then click Server Monitor.

4. Click **Start** to start the server.
5. Click **Close** to close the Server Monitor window. The Server Monitor icon  appears on the taskbar.

i **Tip:** Clicking the **Quit Monitor** button quits (exits) the **Server Monitor** program, but does not stop the server. To stop the server, click **Stop**.

6. Turn on the main power switch on the rear panel of the detector.
7. *Windows Vista, Windows 7, and Windows Server 2008* will automatically detect the new detector and perform the USB installation.

If Windows fails to detect the detector and launches a wizard instead, this indicates that you connected the detector to the computer and turned on the power for the first time before you installed Chromeleon. To resolve the problem:

- a) Click Cancel to exit the wizard.
- b) Turn off the detector.

- c) Install Chromeleon.
- d) Turn on the detector power. Windows will now detect the detector and install the USB software for the detector automatically.

Windows XP

will automatically detect the new detector and launch the **Found New Hardware Wizard**, which guides you through the USB installation. Select the following options:



- a) If asked whether Windows can connect to Windows Update to search for software, select **No, not this time**.
- b) Accept the default option (**Install the software automatically**) and click **Next>**.
- c) Click **Finish** when the wizard reports that the software for the detector has been installed.

If Windows fails to detect the detector and a message box asks for a USB configuration file (cmwdmusb.inf), this indicates that you connected the detector to the computer and turned on the power for the first time before you installed Chromeleon. To resolve the problem:

- a) Click **Cancel** in the Windows message box.
- b) Turn off the detector.
- c) Install Chromeleon.
- d) Turn on the detector power. Windows will now automatically detect the detector and launch the **Found New Hardware Wizard**.

3.5.2 Installing the Detector

After the USB software for the detector has been installed (→ page 34), install and configure the detector in Chromeleon:

1. Start the Chromeleon **Server Monitor** (→ page 34) and the Chromeleon server if they are not yet running.
2. Start the Chromeleon **Server Configuration** program by clicking **Start** on the taskbar. Point to **Programs** (or **All Programs**, depending on the operating system), point to **Chromeleon**, and then click **Server Configuration**.
3. If necessary, click the plus sign beside the server icon   to display the items underneath.
4. Select the timebase to which the detector will be assigned, or create a new timebase (on the **Edit** menu, click **Add Timebase**).
5. Open the **Add device to timebase** dialog box. To do so, click **Add Device** on the **Edit** menu or right-click the timebase and click **Add Device** on the menu.
6. On the **Manufacturers** list, click **Dionex HPLC: UltiMate 3000** and on the **Devices** list, click **DAD-3000(RS) Detector** or **MWD-3000(RS) Detector**.
7. The configuration pages are opened. On each page, verify that the settings are correct and select additional settings if needed. For a description of the pages, see section 3.5.3.1 (→ page 37).
8. Click **OK** to complete the configuration of the detector.
9. Right-click the server symbol under which the timebase is installed, and select **Properties**. On the **Advanced** tab page, check that the value selected under **Spectra** is at least 5000. A lower spectra buffer can result in buffer overflows when a high data collection rate was selected.
10. On the **File** menu, click **Save Installation** and then close the **Server Configuration** program.

3.5.3 Configuring the Detector

3.5.3.1 Initial Installation

During the installation, Chromeleon connects to the detector and transfers the settings from the instrument firmware to Chromeleon, setting the options on the wizard pages accordingly. Verify that the settings are correct and make additional settings if needed. You may reopen the configuration pages later again to change the settings (→ page 40).

i **Tip:** Changing the settings for a specific application in the **Commands** dialog box, in a program file (PGM), or on a control panel will not change the default settings on the configuration pages.

For additional information about a page, click **Help**.

General Page

Shows the general instrument parameters.

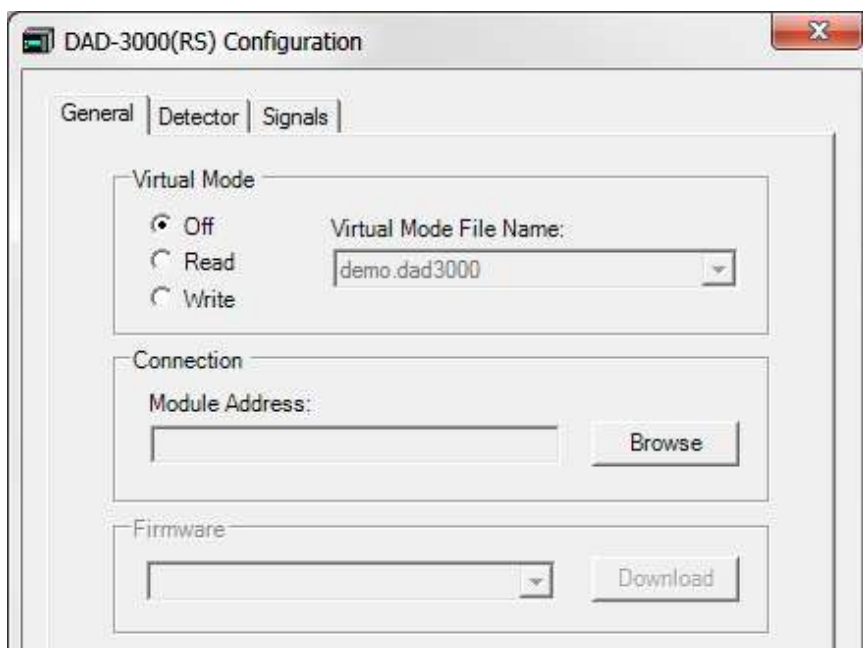

Fig. 10: General page (here: DAD-3000RS)

- **Virtual Mode**
Verify that the virtual mode is set to off. If the virtual mode is enabled, the **Module Address** box will be unavailable. If you exit this page without having entered a module address, the virtual mode will be enabled automatically.

In the virtual mode, Chromeleon simulates detector control and data acquisition.

- ◆ Click **Read** to read and display data from an existing demo file instead of real data. Select the file from the **Virtual Mode File Name** list.
- ◆ Click **Write** to save the data currently delivered by the detector as a demo file. Enter the file name in the **Virtual Mode File Name** field or select a name from the list.
- **Module Address**
Select the module address of the detector. Click Browse and then double-click the detector that you want to use on the Device List. The address is automatically entered in the **Module Address** field. Chromeleon connects to the detector and transfers the settings from the instrument firmware to Chromeleon, setting the options on the pages accordingly. Confirm the related message with **OK**.
- **Download**
Click this button to transfer the current detector configuration to Chromeleon. (The button appears dimmed if the virtual mode is enabled.) The detector is shipped with the most recent firmware version. If a firmware update is ever required, follow the steps in section 7.7 (→ page 117).

Detector Page

The Detector page shows the detector configuration.

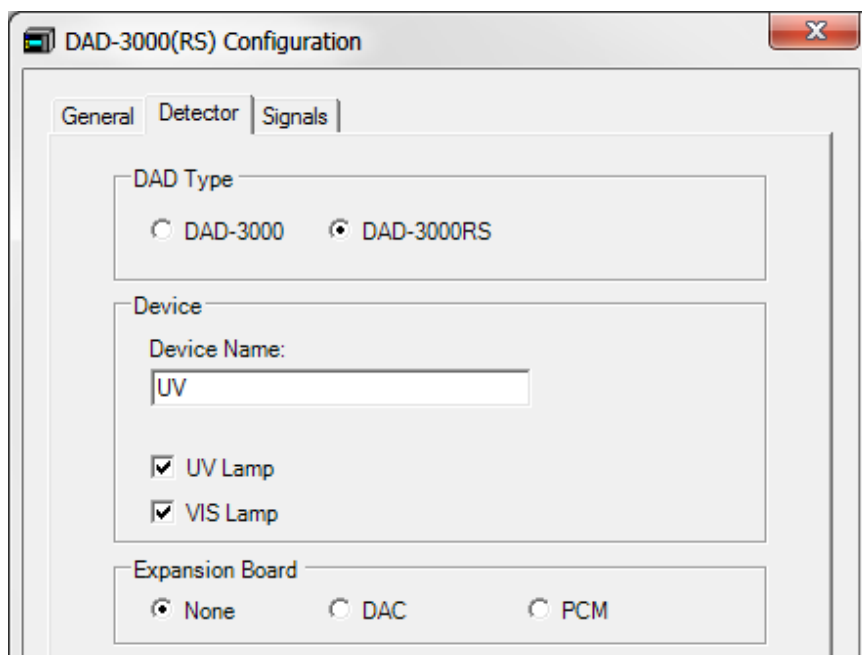

Fig. 11: Detector page (here: DAD-3000RS)

- **DAD Type**
Select the detector type. Make sure that the selected options corresponds to the actually installed detector type.

- **Device**
 - ◆ **Device Name**

Displays the name used to identify the detector the installation environment and in the Chromeleon client program. To control the detector with the existing control panels, accept the default name. If you enter a different name, you may have to re-link the controls on the control panels and edit the device name in the program files.
 - ◆ **UV Lamp**

This check box must be selected if a deuterium lamp is installed. (As the detectors are shipped with a deuterium lamp, this check box is selected by default.)
 - ◆ **VIS Lamp**

This check box must be selected if a tungsten lamp is installed. (As the detectors are shipped with a tungsten lamp, this check box is selected by default.)
- **Expansion Board**
 - ◆ **DAC**

This check box must be selected if optional analog outputs are installed. (→ page 22).
 - ◆ **PCM**

This check box must be selected if a pH and conductivity monitor is installed (→ page 23).

Signals Page

The page lists all signals that the detector can record. The signal type and name of each signal is displayed. To allow raw data collection for a signal, select the **Enabled** check box next to the signal name. If the check box is cleared, the detector cannot collect raw data for the signal. To change a signal name, overwrite the existing name directly in the Name line.

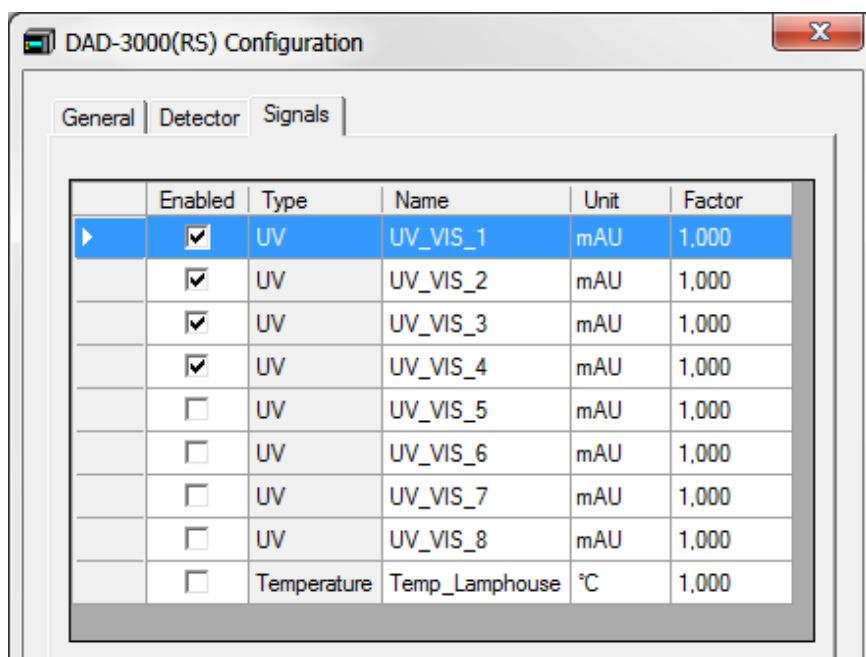

Fig. 12: Signals page (here: DAD-3000RS)

The **Temp_Lamphouse** signal check box is selected by default. Accept this setting if you want to record the lamp house temperature. With this setting, Chromeleon generates the appropriate channel for recording the temperature signal. For more information, see 5.6.4 (→ page 76).

3.5.3.2 Changing the Configuration Properties

You may reopen the configuration pages later again to change the settings.

1. Start the **Server Configuration** program (→ page 36).
2. Right-click the **DAD-3000(RS) Detector** or **MWD-3000(RS) Detector** in the timebase and click **Properties** on the menu.
3. Change the settings as needed. For a description of the pages, see section 3.5.3.1 (→ page 37).
4. To save the changed configuration, click **Save** on the **File** menu and then close the **Server Configuration** program.

3.6 Setting Up the Detector in DCMSLink

To set up the detector in DCMSLink, refer to *DCMSLink Installation Guide*, which is provided on the DCMSLink DVD in the *Additional Documents\DCMSLink User Documents* folder.

1. Install and configure the DCMSLink-Software (→ *DCMSLink Installation Guide*).
2. Open the Chromeleon **Server Configuration** program (→ *DCMSLink Installation Guide*).
3. In the **Server Configuration** program, add the detector to the timebase. The steps in section 3.5.2 apply equally (→ page 36).
4. Configure the detector. The steps in section 3.5.3 apply equally (→ page 37).

For more information about DCMSLink, refer to the *DCMSLink Quick Start Guide*, which is also provided on the DCMSLink DVD and to *DCMSLink Help*.

4 Preparation for Operation (Startup)

4.1 Overview of Actions

 **Important:** Two locks on the bottom of the detector secure the optics during shipment (→ Fig. 7, page 30). Loosen these locks before you operate the detector for the first time.

 **Important:** Deux vis sur le dessous de détecteur fixent le système optique durant le transport (→ Fig. 7, page 30). Avant de commencer à utiliser le détecteur, assurez-vous que vous avez desserré ces vis.

After you have unpacked, positioned and connected the detector as described in sections 3.1 through 3.4 (→ page 29 and following), prepare the detector for operation. Follow the sequence of steps below:

1. No flow cell is installed when the detector is shipped. Install a suitable flow cell first (→ page 109).
2. Connect the drain tubing (→ page 45).
3. Connect the detector to the separation column.
4. Set up the detector in Chromeleon if it is not already set up (→ page 34).
5. Turn on the detector (→ page 49).
6. Check and change the leak sensor setting if necessary (→ page 68).
7. Adjust the brightness and contrast of the front panel display if necessary (→ page 68).
8. As an alternative, you can connect either a DAC plug-in board or a pH and conductivity monitor:
 - a) *If you want to connect additional evaluation devices to the detector*
Install the DAC plug-in board and configure the analog outputs (→ *DAC board installation instructions*).
 - b) *If you want to connect an additional pH and conductivity monitor to the detector*
Install the PCM-3000 and configure it in Chromeleon (→ *PCM-3000 installation instructions*).
9. Before starting sample analysis, equilibrate the entire system (→ page 45).

4.2 General Precautions for Connecting Capillaries

When connecting capillaries, observe the following general precautions:

- Observe the precautionary statements for capillaries and capillary connections in section 1.2.2 (→ page 5).
- UltiMate 3000 systems with stainless steel fluidics are shipped with Viper capillary kits. The kits include a Viper capillary for connecting the detector to the separation column when the system includes only one detector. For UltiMate 3000 RSLC system, you can use the post column cooler to connect the detector to the column as an alternative.
- If you are using more than one detector in a system, for example, a diode array detector and a fluorescence detector, another Viper capillary is available in the fluorescence detector flow cell accessories.
- Use only the capillaries shipped with the module and original spare capillaries.
- Depending on the fitting connection, also observe the following:

- ◆ *Viper fitting connections*

Loosen or tighten the Viper connection only using the black knurled screw and only with your hand (do not use tools). The knurled screw can be easily removed and reattached to the capillary at any time. Viper capillaries are designed to be leak-free for all pressures that arise in UltiMate 3000 systems simply by tightening them with your hand. If you observe leakage on the connection, tighten the screw a little further. If leakage continues, remove the capillary, clean the capillary ends carefully by using a cloth or tissue wetted with isopropanol, and reinstall the capillary. If the connection continues to leak, replace the Viper capillary.

When connecting the Viper capillary to the flow cell inlet, observe the guidelines in the Installation Instructions shipped with the capillary.

Capillaries with Viper fitting connections can be reused also for a different connection.

- ◆ *Conventional fitting connections (non-Viper)*

Do not over-tighten these fitting connections. If you observe leakage on the connection, tighten a little further.

If leakage still exists, first clean the connection port with a cleaning swab (part no. 6040.0006). If this does not eliminate the problem, replace the capillary and/or fitting.

Reuse used fittings and ferrules only for the same capillary connection. This is to avoid increased dead volume or damage to the system and leakage.

4.3 Connecting the Drain System

To discharge liquid leaks and waste, the detector has a drain port at the bottom right of the instrument.



Fig. 13: Drain port

Direct liquid leaks to waste through the drain system of the UltiMate 3000 system. Direct liquid leaks to waste via the drain system of the UltiMate 3000 system, using the components from the drain kit. The kit is shipped with the UltiMate 3000 pumps and can be ordered separately (part no. 6040.0005). The kit includes all required components and detailed installation instructions. If there is more than one detector in your system and you need an additional tee piece, you can find one in the accessories kit of the fluorescence, multiple wavelength, or diode array detector.

4.4 Equilibrating the System

Before using the detector for sample analysis, equilibrate the UltiMate 3000 system:

1. Pump the starting solvent through the entire system until the system is free of any other liquid composition.
2. Heat or cool all temperature-controlled devices, such as the column oven, to the temperature required for the application.
3. Set the detector wavelengths and turn on the lamps.
4. Monitor the pump pressure. Verify that the reading is correct for the application and is stable.
5. Monitor the detector signal and verify that the baseline signal is at the expected reading for your application and is stable.

Perform system equilibration in Chromeleon or select the required commands and parameters on the front panel menus of the instruments.

To equilibrate the system from Chromeleon

- Select and perform the operating commands and parameters from the **Commands** dialog box.
- Create and run an equilibration program to automate the process (→ page 55).
- Use the SmartStartup Wizard to create and run the equilibration program (see below).

To create the equilibration program with the SmartStartup Wizard

1. To open the wizard, select **SmartStartup** on the **Batch** menu.
2. Follow the instructions as they appear on each page of the wizard. For additional information about a page, click **Help**.
3. After you finish the wizard, Chromeleon
 - ◆ Generates an equilibration program and sequence.
 - ◆ Opens the equilibration control panel for the instruments in the timebase (→ Fig. 14, page 46).
 - ◆ Opens the **Start Batch on** dialog box.Click **Start** to begin equilibration.

The equilibration panel shows the equilibration status of each instrument in the system.

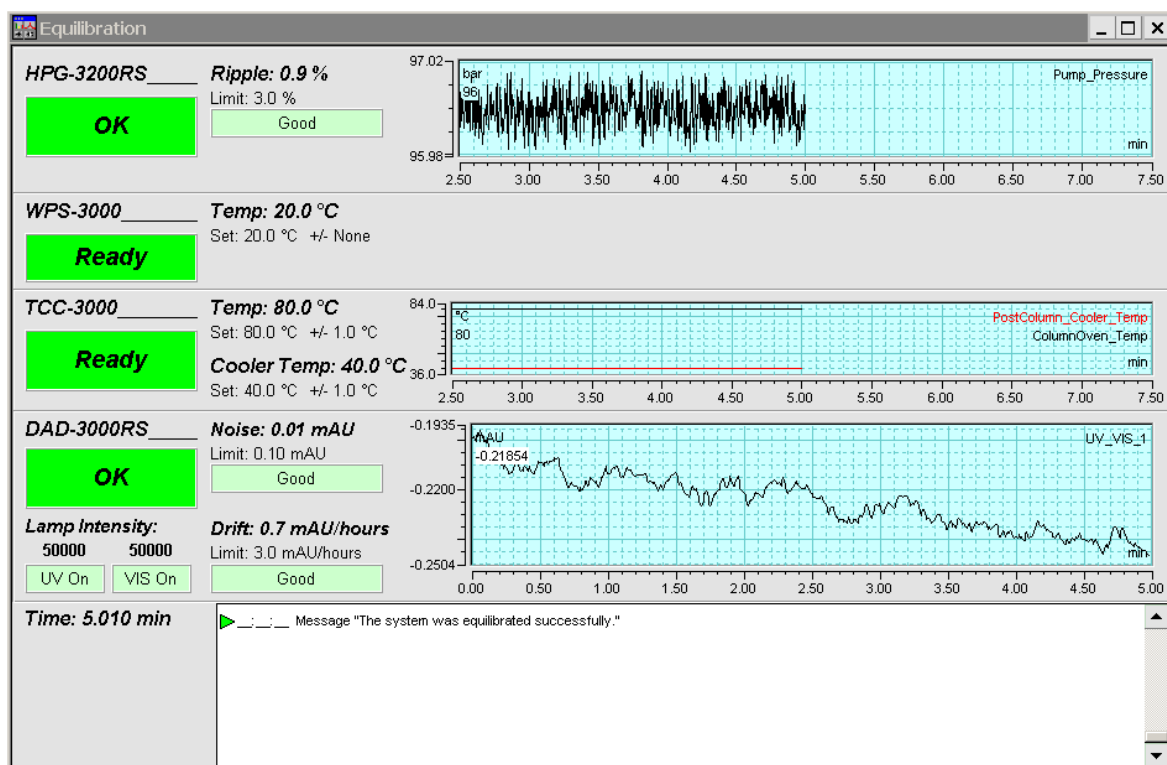

Fig. 14: Equilibration window

To equilibrate the system from the front panel menus

Select and perform the operating commands and parameters on the front panel menus of the instruments. For information about the detector menus, see section 5.4.2.1 (→ page 59). For information about the menus of other system modules, see the *Operating Instructions* for the respective module.

4.5 General Guidelines for Detector Operation

The following sections offer general guidelines for detector operation. For information about how to optimize the detector performance, see section 5.6.1 (→ page 69).

4.5.1 Wavelength

There are two key criteria for determining the wavelength for an analysis:

- Sample components should absorb strongly at the selected wavelength. Preferably select a wavelength on the absorption maximum.
- The mobile phase should be "transparent", showing little or no absorption, at the selected wavelength.

4.5.2 Mobile Phases

Mobile phase quality significantly affects detection limits and instrument performance. To ensure optimal performance of the detector, observe the following guidelines:

- Prepare all mobile phases with HPLC-grade solvents, reagent-grade chemicals, and filter HPLC-grade water.
- Degas all mobile phases before use and maintain them in a degassed state.
- Strong bases can etch the silica windows of the flow cell. If the mobile phase is a base, make sure the mobile phase concentration does not exceed 0.1 M. If the concentration of the base is greater than 50 mM, disconnect the separation column and flush the system with HPLC-grade water for 5 minutes at 1.0 mL/min immediately after the analysis.
- Mobile phase pH affects not only the retention time of the separation, but the sample absorbance and the background absorbance of the mobile phase.
- When changing from a buffer to a different operating mobile phase, be sure the solvents are miscible and will not induce precipitation of the buffers. Flush the cell with a buffer-compatible solvent (in most cases, HPLC-grade water) immediately after the analysis. Do not allow buffers to remain in the cell for extended periods.

For information about the properties of commonly used mobile phases, see section 10 in Table 1 (→ page 127).

4.5.3 Mobile Phase Delivery System

The pumping system should deliver continuous flow while ensuring intermixing of the mobile phase (if gradient elution is used). Fluctuations in pump backpressure can cause baseline noise. If the noise is synchronized with the pump stroke, check your HPLC pump.

The plastics present in some solvent delivery systems are not fully compatible with the solvents commonly used in chromatography. Therefore, plastic components may dissolve, and thus impair UV detection.

For UV operation, these guidelines are recommended:

- The mobile phase reservoir should be glass.
- All tubing connections should be made of materials suitable for HPLC applications (for example, PTFE, ETFE, PEEK, stainless steel, or titanium), as required for the operating pressures and application.
- Some pump seals incorporate a band spring to preload the seal during the vacuum stroke of the piston. The band spring should be made of stainless steel, a fluoropolymer (perfluoroelastomer or fluorosilicone), or another material of known quality.

If you are working with an UltiMate 3000 system, using original Dionex parts only, all the above recommendations are met.

4.5.4 Flow Cell

To ensure optimum performance of the flow cells, observe the following guidelines:

- All parts of the flow cell that are exposed to solvents are made of fused silica, PEEK (polyetheretherketone), stainless steel, or PTFE (polytetrafluorethylene). The chemical resistance of a flow cell depends on the solvents used for the analysis. This applies particularly to strongly acid solvents with high buffer concentrations and certain solvents, such as THF (tetrahydrofuran) and CHCl₂ (dichloromethane).
- When the detector is fitted with a PEEK flow cell, Thermo Fisher Scientific advises against operating the detector for longer periods (5 minutes or longer) without flow while a lamp is on. The heat from the lamp may damage the flow cell.
- For information about how to clean a flow cell, see page 108.

4.5.5 Lamps

To achieve optimum results, allow 60 minutes for the lamps to stabilize before beginning operation.

5 Operation and Maintenance

For information about how to control the detector via the Chromeleon Chromatography Management System, see section 5.3 (→ page 51).

In addition, function keys and menus are available on the front panel display to facilitate initial installation of the detector. These keys and menus allow you to perform certain actions directly from the detector display:

- Turning the lamps on or off
- Performing autozero
- Clearing alarms
- Setting the display contrast and brightness

For details, see section 5.4 (→ page 57).

5.1 Power-Up

To start the detector for the first time, turn on the main power switch on the rear panel of the detector. The following sequence of events occurs when the detector is powered up

- For a short time, general information about the detector appears on the display: device type, firmware version, and serial number.
- The detector runs a series of internal tests. (The test takes about 30 seconds.) During these self-diagnostics, all of the main components are checked. When the self test was successful, the initial screen changes to the status screen (→ page 50).
- If an error is detected, the detector is not ready for analysis. The **Status** LED on the front panel is red and a message appears on the front panel display. If the detector is operated from Chromeleon, the message appears also in the Chromeleon Audit Trail. Turn off the detector, take appropriate remedial action (→ page 81), and turn on the detector again.

For routine operation, leave the main power switch on. For routine on/off control, use the standby button on the front of the detector (→ page 20). Press and hold the button for about one second to allow the detector to change the mode. Turn the main power switch off when instructed to do so, for example, before performing a service procedure.

5.2 Status Screen

When the self test was successful, the initial screen changes to the status screen.

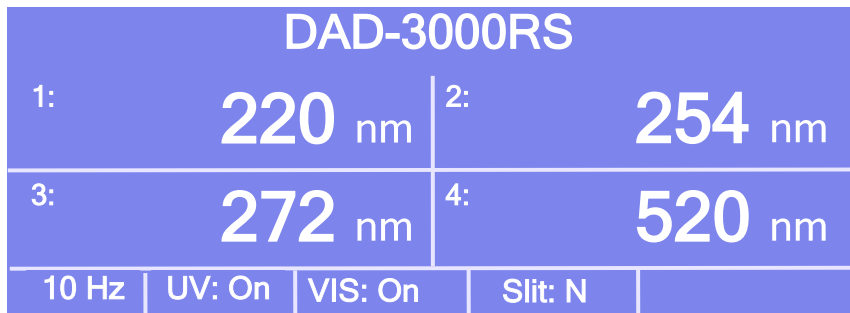

The screenshot shows a blue status screen for the DAD-3000RS. At the top, it displays 'DAD-3000RS'. Below this, there are four wavelength settings arranged in a 2x2 grid: 1: 220 nm, 2: 254 nm, 3: 272 nm, and 4: 520 nm. At the bottom, there are five status indicators: 10 Hz, UV: On, VIS: On, Slit: N, and a blank space.

DAD-3000RS				
1:	220 nm	2:	254 nm	
3:	272 nm	4:	520 nm	
10 Hz	UV: On	VIS: On	Slit: N	

Fig. 15: Status screen (example)

The status screen shows the following information:

- Data collection rate
- Number of wavelengths
- Status of the lamps (on or off)

You can adjust the screen brightness or screen contrast to your requirements from Chromeleon or on the detector display (→ page 68).

5.3 Chromeleon Software

Before you begin, verify that

1. The Chromeleon software is installed on the computer and the license code is entered. The computer meets the system requirements (→ page 26).
2. The detector is connected to the Chromeleon computer via a USB connection.

 **Tip:** Verify that Chromeleon is installed on the computer and that the license code is entered *before* you connect the detector to the USB port on the Chromeleon computer and turn on the detector power. Only then, the USB driver for the detector is automatically loaded and the Windows operating system can detect the detector when the power is turned on.

3. The detector is set up in Chromeleon, as described in section 3.5 (→ page 34).

Before you can operate the detector from Chromeleon, you have to connect the timebase in which the detector is installed to the Chromeleon client program (→ page 51).

Two modes of software control are available:

- **Direct control** with the parameters and commands from the **Commands** (F8) dialog box (→ page 52) or from a control panel (→ page 53).
- **Automated control** with a control program (PGM) (→ page 55).

5.3.1 Connecting to Chromeleon

1. Start the Chromeleon **Server Monitor** and the Chromeleon server if they are not yet running (→ page 34).
2. Start the Chromeleon client by clicking the Chromeleon icon  on the desktop. If the Chromeleon icon is not on the desktop, click **Start** on the taskbar, point to **Programs** (or **All Programs**, depending on the operating system), point to **Chromeleon**, and then click **Chromeleon**.
3. Connect the Chromeleon client program to the timebase in which the detector is installed. For details about how to do this from the **Commands** dialog box, see page 52. For details about how to do this on a control panel, see page 53.

When the detector is correctly connected to Chromeleon

- The **Connected** LED on the front panel is green.
- Front panel input related to the measurement is disabled.
- The **Standby** button on the front panel remains active.
- Functions for estimating the lifetime of consumables and monitoring and recording service and (re)qualification information are provided (→ page 75).
- Diagnostic tests are provided (Chromeleon 6.80 from SR10 on) to check the performance of certain detector components and the overall performance of the instrument (→ page 77).

Before turning off the detector by the main power switch, always **disconnect** the module in Chromeleon.

5.3.2 Direct Control

With direct control, you select operating parameters and commands in the **Commands** (F8) dialog box. Direct commands are executed as soon as they are entered. For routine operation, most parameters and commands are available also on a control panel.

To open the Commands dialog box for the detector

1. Open a control panel (any panel is possible). To open a control panel, open the Chromeleon Browser and double-click a control panel in the **Dionex Templates/Panels** folder.
2. Connect the control panel to the timebase in which the detector is installed. On the **Control** menu, select **Connect to Timebase**, and then select the timebase on the **Timebase** tab. (The **Control** menu is visible only when a control panel is open.) For information about the **Timebase** dialog, click **Help**.
3. Press the F8 key or select **Command** on the **Control** menu.
4. To see the parameters and commands that are available for the detector, click the plus sign next to **UV**.

The commands and parameters available in the dialog box vary, depending on the

- ◆ Chromeleon version
- ◆ Options selected for the detector in the **Properties** dialog (→ page 37).
- ◆ Display filter level (**Normal**, **Advanced**, or **Expert**)

5. Change the display filter level if necessary. Right-click in the commands list and select the filter level on the menu.

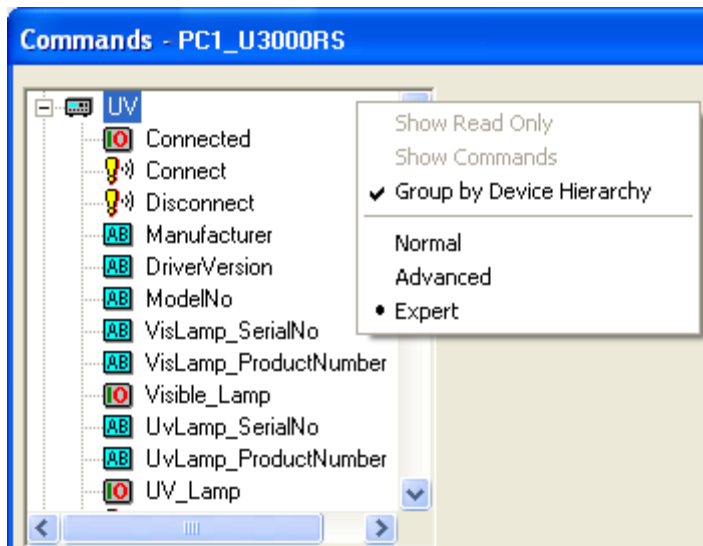

Fig. 16: Commands dialog box

6. Verify that the detector is connected to Chromeleon. If it is not, select **Connect** to connect the detector.

For a list of the commands and properties that are supported for the detector, see the Chromeleon Help. In addition to the detector commands and parameters, the **Commands** dialog box provides access to all of the commands and parameters available for all devices that are installed in the selected timebase.

To open a control panel

1. On the **View** menu, click **Default Panel Tabset** or click the corresponding icon on the toolbar , and then connect to the Chromeleon server.

Chromeleon creates centralized control panels, called panel tabsets, for all timebases available on the Chromeleon server. A panel tabset provides control panels for the individual instruments in a timebase and, in addition, one or more panels for performing system-wide functions, for example, creating and running sequences. For more information about panel tabsets, see the Chromeleon Help.

2. On the Panel Tabset for your timebase, click the page for the detector.
3. Verify that the detector is connected to Chromeleon (the LED next to the Connect button is green). If it is not, click **Connect**.

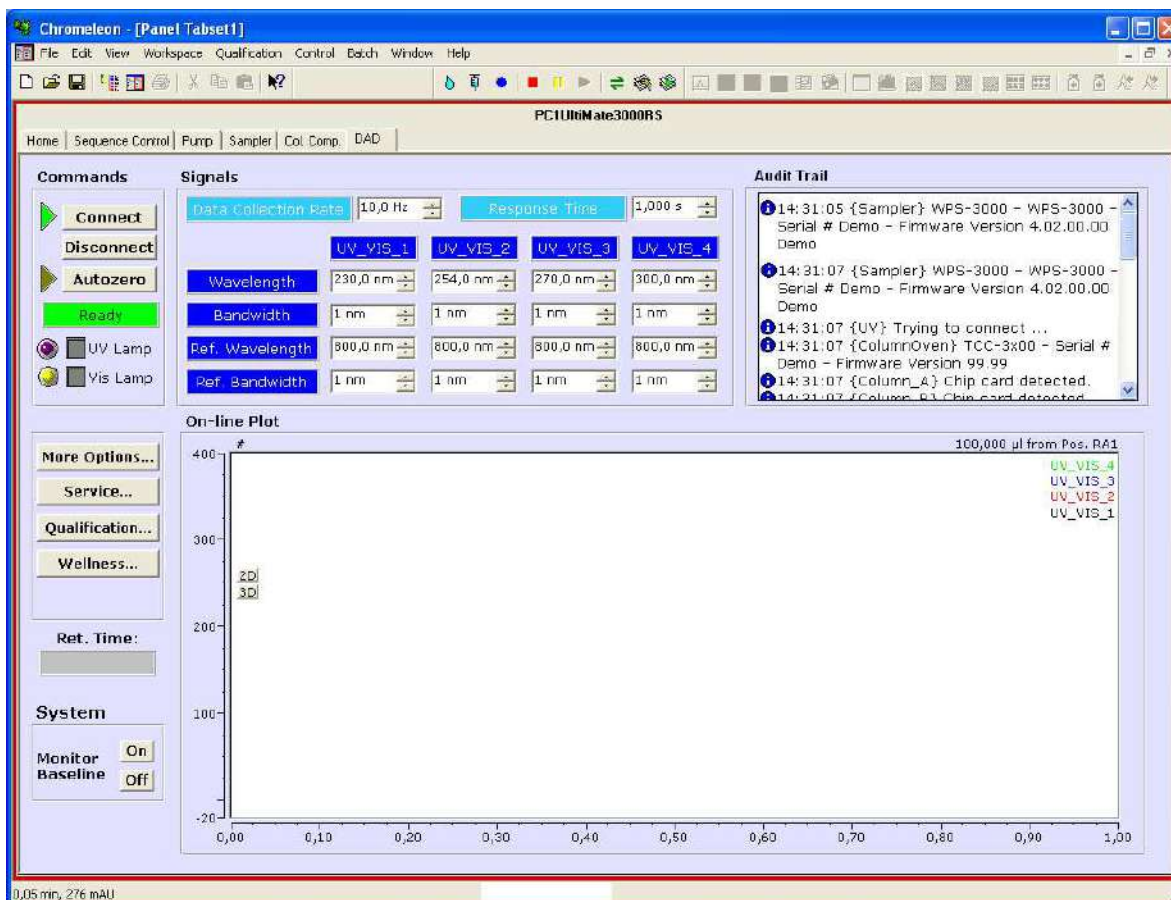

Fig. 17: Detector Control Panel on the Panel Tabset

The control panel provides access to the operating parameters and commands required for routine operation of the detector. Additional functions are available in the **Commands** dialog box. To open the **Commands** box from the panel tabset, select **Command** on the **Control** menu.

5.3.3 Automated Control

With automated control, you create a program file (PGM) for automated operation of the detector. Programs can be created automatically with the help of a software wizard or manually by editing an existing program.

In addition to programs for sample analysis, you can also create programs for special purposes, for example, to automate system shutdown (→ page 79) or to ensure that the system automatically restarts operation as desired after a power failure. For details, see the Chromeleon Help.

To create a program with the Program Wizard

1. Open the Program Wizard. On the **File** menu, select **New**, and then select **Program File**.
2. The wizard guides you through program creation. On each wizard page, make the desired settings or accept the default values. For additional information about a page, click **Help**.
3. After you finish the wizard, Chromeleon automatically creates the corresponding program.
4. To start the program, follow the steps below (→ page 56).

To create a program manually

1. Open an existing program.

Select and double-click the program you want to open.

- or -

On the **File** menu, select **Open**. In the dialog box, select **Program** on the **Object of Type** list and select the program.

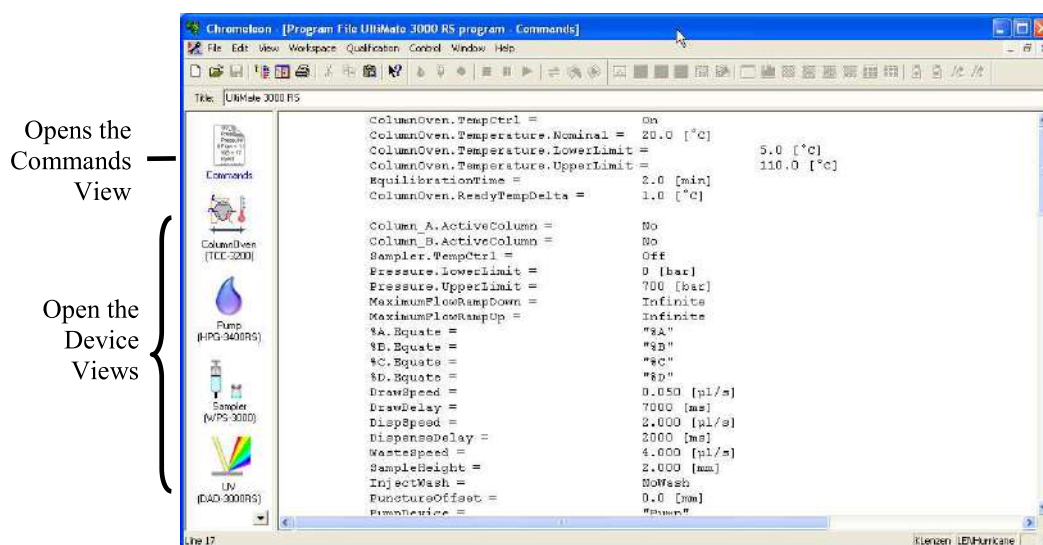

Fig. 18: Chromeleon program file (here program shown in the Commands view)

2. Change the settings in the program as desired.

The easiest way to edit a program is to do this in the Device Views (→ Fig. 18). Click a device icon and change the settings on the device pages. Editing the program in the Device Views ensures correct command syntax.

If you cannot edit a certain parameter in the Device View, click **Commands** to open the Commands View. The **Commands** view shows the entire program, listing the control commands in chronological order. For more information, see the Chromeleon Help.

3. To start the program, follow the steps below.

To start a program

Program for sample analysis

1. Create a sample list (sequence). A sequence must include the program and a method for evaluating the sample data (for example, for peak identification, area determination, and amount determination).
2. Assign the program and method to each sample on the list.
3. Add the sequence to the batch and start the batch.

For information about each of these steps, see the Chromeleon Help.

Other programs

Add the program to the batch and start the batch.

5.4 Display Screens (Function Keys and Menus)

Via the function keys and menus that are available on the front panel display, you can make several settings or access information directly from the detector.

For information about the function keys, see section 5.4.1 and page 59. For information about the menus, see section 5.4.2.1 (→ page 59).

5.4.1 Showing the Function Keys

Four white spots on the front panel mark the positions of the function keys (→ table on page 58).

To show the keys, touch the position of the utmost left spot on the display with the menu pen (part no. 6300.0100). The menu pen is included in the accessories kit for the UltiMate 3000 autosampler.



Fig. 19: Showing the function keys (here: under Chromeleon control)

The function keys replace the information in the bottom line of the status screen. If no key is selected, the bottom line of the status screen is restored after about 5 seconds.

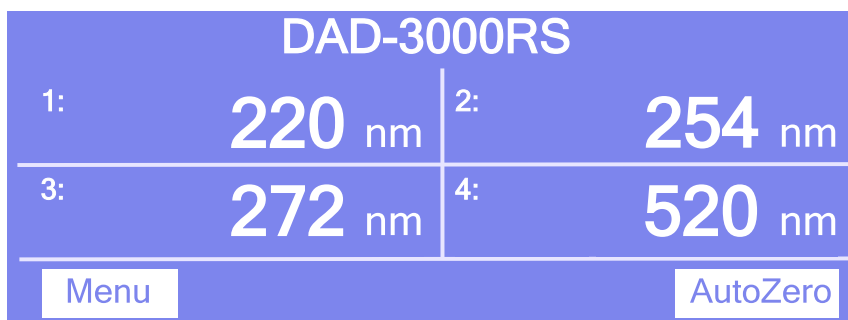

Fig. 20: Function keys (here: not connected to Chromeleon)

To...	Select...
Open the Main menu (→ page 61)	Menu
<i>If a PCM-3000 is installed (firmware version 2.30 and later)</i> Switch between the display mode "Standard" and "pH/Cond" (two detector channels as well as pH and conductivity value)	pH/Cond or Standard
Perform automatic null balancing (= the current detector signal is interpreted as 0. Therefore, no absorbing sample should be in the flow cell when AutoZero is performed; only available if the detector is not connected to Chromeleon.)	AutoZero

When the detector is connected from Chromeleon, front panel input related to the measurement is disabled to prevent changes to the operating parameters. Parameters that do not interfere with the measurement, such as the screen brightness or contrast, can still be changed.

5.4.2 Detector Menus

Fig. 21 shows an overview of the detector menus. For information about the general menu layout and structure, see page 59. For information about the commands and parameters that are supported by the menus, see sections 5.4.2.2 through 5.4.2.4 (→ page 61).

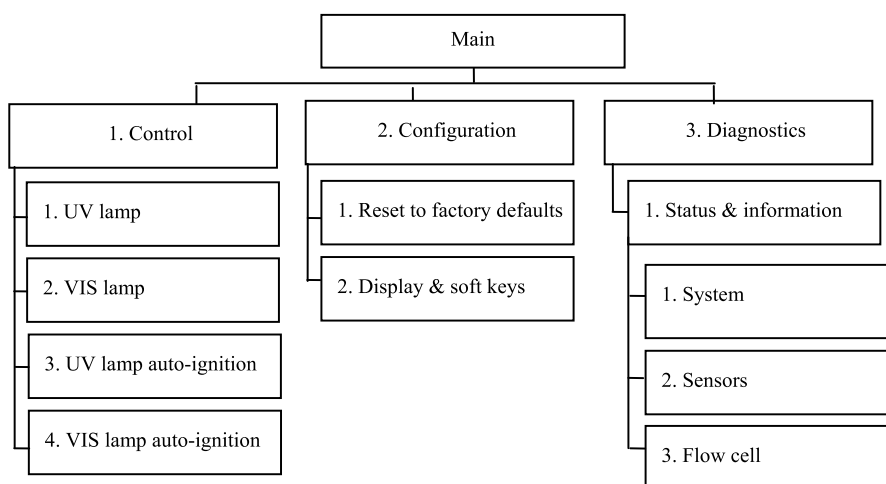

Fig. 21: Detector menus

5.4.2.1 General Menu Layout and Structure

In general, the menu layout is as follows:

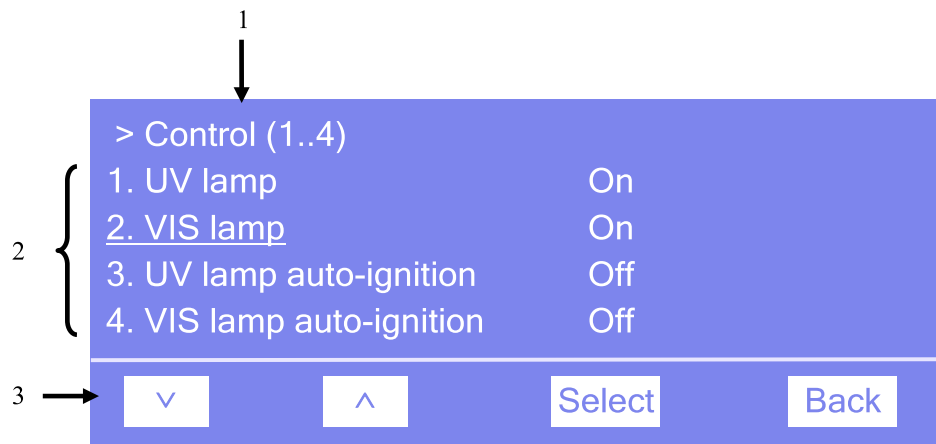

Fig. 22: Menu layout (here Control menu)

No.	Description
1	Reports the menu name and the number of items on the menu list.
2	The menu items appear on a list and are numbered consecutively. The selected item is underlined.
3	Navigation bar

Select an item with the arrow up or down key—the selected item is underlined. Confirm your selection with **Select**. **Back** returns you to the previous menu level.

The selected menu item or parameter determines which function keys appear on the navigation bar:

To...	Select...
Return to the previous entry on a list. If the list contains 5 or more items, you can use the arrow up key to scroll up through the list, after reaching the first line (→ Key autorepeat , page 63).	^
Increment numerical values.	^
Proceed to the next entry on a list. If the list contains 5 or more items, you can use the arrow down key to scroll down through the list, after reaching the fourth line (→ Key autorepeat , page 63).	v
Proceed to the next figure in a number. Any decimal point is skipped.	>
Confirm the selection and activate the input field if applicable. Note: If an item is read-only, the Select key will not be available.	Select
- Return to the previous menu level. - Return to the status screen (from the Main menu).	Back
Toggle between two operating states, for example, between lamp On and lamp Off .	Toggle

To...	Select...
Confirm the selection and perform the action. For example, if you change the operating status of a lamp from Off to On , you have to select OK to confirm the change and turn on the lamp.	OK
Cancel the action and restore the last value. For example, if you change the operating status of a lamp from Off to On , select Cancel to undo this action and to restore the previous operating state.	Cancel
Note: Depending on the selected option, specific keys may replace these general keys.	

If an error is found, one or more messages appear on the front panel display. In this case, the **Prev**, **Next**, and **Clear** keys appear on the navigation bar.

To...	Select...
Return to the previous message.	Prev
Proceed to the next message.	Next
Remove a message from the display.	Clear

5.4.2.2 Main Menu

The **Main** menu provides top-level access to the menu structure. To open the **Main** menu, show the function keys and select **Menu** (→ page 57).

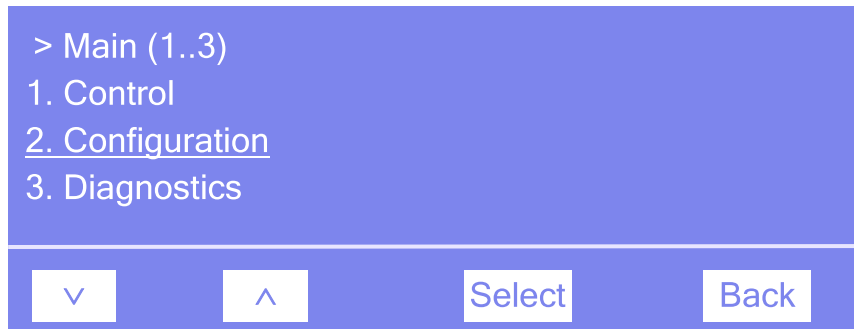

Fig. 23: Main menu

Select an item with the arrow up or down key—the selected item is underlined. Confirm your selection with **Select**. **Back** returns you to the status screen.

For information about the menus, see

- Control Menu (→ page 62)
- Configuration Menu (→ page 63)
- Diagnostics Menu (→ page 64)

5.4.2.3 Control Menu

On the **Control** menu, you can make the settings for the lamps.

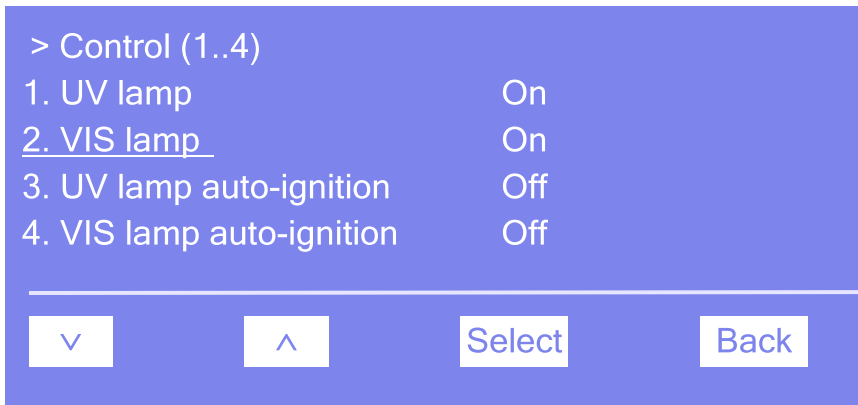

Fig. 24: Control menu

To...	Select...
Turn the deuterium lamp on or off .	UV lamp
Turn the tungsten lamp on or off .	VIS lamp
Turn on the deuterium lamp whenever the detector is powered up or when operation is resumed after standby mode has been cancelled.	UV lamp auto-ignition
Turn on the tungsten lamp whenever the detector is powered up or when operation is resumed after standby mode has been cancelled.	VIS lamp auto-ignition

5.4.2.4 Configuration Menu

The **Configuration** menu provides information about the detector configuration and allows you to make the required settings or change the settings.

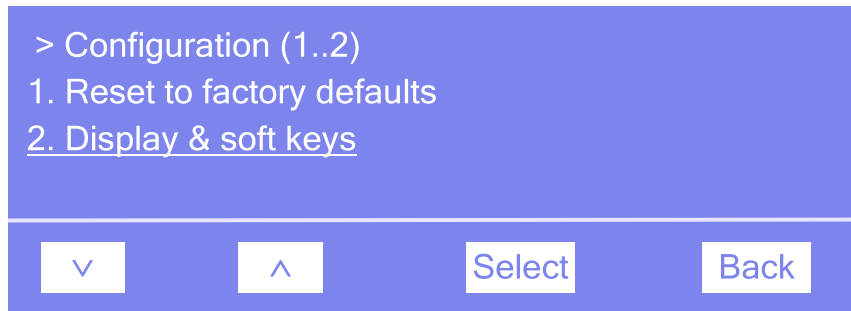

Fig. 25: Configuration menu

To...	Select...
Reset all important detector settings to the standard settings. In the Reset to factory defaults? dialog box, select OK to confirm the restore the factory settings or select Cancel to keep your settings.	Reset to factory defaults
Set the display and function key parameters: Brightness—sets the screen brightness. Contrast—sets the screen contrast. Key sound—sets whether a beep sounds when you select a function key: On —yes or Off —no. Key autorepeat—sets whether the keystroke is automatically repeated when you remain on the key for a longer period, for example, to change a value quickly (On = yes or Off = no).	Display & soft keys

5.4.2.5 Diagnostics Menu

The **Diagnostics** menu provides information for diagnostic purposes (read-only).

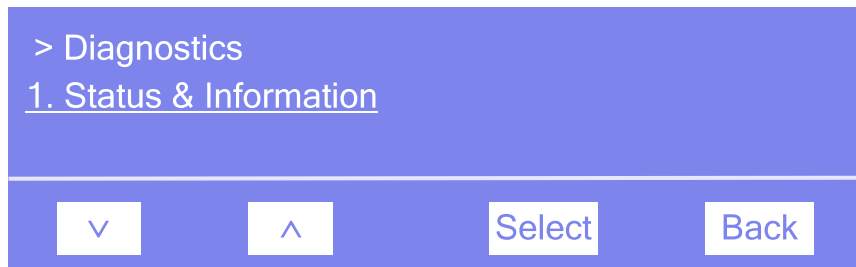

Fig. 26: Diagnostics menu

To...	Select...
See general information about the detector (see the following table). The information is read-only.	Status & information

On the **Status & Information** menu, you can see the following information:

To...	Select...
The detector, such as detector type and firmware version.	System
The status of the front door sensor (Open or Closed) and the leak sensor (Leak or OK).	Sensors
The flow cell, such as, serial number, flow cell type, and flow cell material.	Flow cell

5.5 Operational Settings

This section provides information for operating the detector.

To learn more about ...	See page ...
Turning on the Lamps	See below.
Setting the Wavelength for UV_VIS Channels	66
Setting the 3D Wavelength Range	66
Starting and Stopping Data Acquisition	67
Detecting Liquid Leaks	68
Adjusting the Screen Brightness or Contrast	68

In addition, note the information about special functions that are available for the detector in Chromeleon (→ page 69).

5.5.1 Turning on the Lamps

 **Tips:** To achieve optimum results, allow 60 minutes for the lamps to stabilize before beginning operation.

When the lamp was turned off, a cooling-off period of 5 minutes is required before the lamp can be ignited again. The detector monitors the cooling-off period. If the lamp is turned on again after less than 5 minutes, an error message appears on the front panel display and in the Chromeleon Audit Trail.

You can set that the lamps are turned on automatically whenever the detector is powered up or operation is resumed after standby mode has been cancelled. You can also turn on the lamps manually. It is not possible to turn a lamp on or off while data acquisition is running.

To turn on the lamps automatically

- *From Chromeleon*
Open the **Commands** dialog box for the detector. To have the deuterium lamp turned on automatically, select and set **AutoactivateUV_Lamp** to **On**. To have the tungsten lamp turned on automatically, select and set **AutoactivateVisible_Lamp** to **On**.
- *From the front panel display*
Show the function keys and select **Menu**, select **Control**, and set **UV lamp auto-ignition** to **On** to automatically turn on the deuterium lamp. To have the tungsten lamp turned on automatically, select and set **VIS lamp auto-ignition** to **On**.

To turn on the lamps manually

- *From Chromeleon*
Open the **Commands** dialog box for the detector.
Set **UV_Lamp** to **On**, to turn on the deuterium lamp.
Set **Visible_Lamp** to **On**, to turn on the tungsten lamp.
- *From the front panel display*
Show the function keys and select **Menu**, and then select **Control**. To turn on the deuterium lamp, set **UV lamp** to **On**. To turn on the tungsten lamp, set **VIS Lamp** to **On**.

For information about the wavelength verification, refer to page 99.

5.5.2 Setting the Wavelength for UV_VIS channels

Set the wavelengths at which the analysis is performed in Chromeleon. Observe the general guidelines on pages 47 and 71.

To set the wavelengths

On the **Signals** page in the detector **Properties** dialog box, verify that the signals you want to record were selected by the **Enabled** check box during the installation of the detector (→ page 40). If they were not, the detector cannot collect raw data only for these signals.

1. Open the **Commands** dialog box for the detector.
2. Select the signal you want to record (**UV_VIS_1** through **UV_VIS_8**).
3. Enter the wavelength in the input field.

5.5.3 Setting the 3D Wavelength Range (DAD-3000(RS) only)

When recording 3D data, Chromeleon records all wavelengths between 190 and 800 nm by default. However, you can restrict the recorded range in Chromeleon to the wavelengths that are relevant for your analysis, thus reducing the amount of data that is recorded.

To set the wavelength range

1. Open the **Commands** dialog box for the detector.
2. Select the **3DFIELD** signal.
3. Enter the start wavelength of the wavelength range in the **MinWavelength** field.
4. Enter the end wavelength of the wavelength range in the **MaxWavelength** field.

In addition to the wavelength range, you can select a reference wavelength, reference bandwidth and bunch width for the 3D field in the **Commands** dialog box. For information about these parameters, refer to section 'Optimizing Detector Performance' (→ page 69).

 **Tip:** On the control panel for the detector, click **More Options** and execute the related commands.

5.5.4 Starting and Stopping Data Acquisition

You can start and stop data acquisition in Chromeleon. In addition, you can watch the progress of data acquisition on the display.

To start or stop data acquisition in Chromeleon

1. Open the **Commands** dialog box for the detector.
2. Select the signal for which you want to start or stop data acquisition (**3DFIELD**, **UV_VIS_1** through **UV_VIS_8**).
3. Perform the **AcqOn** command to start data acquisition.
Perform the **AcqOff** command to stop data acquisition.

Monitoring the progress of data acquisition on the detector display

You can watch the progress of data acquisition on the display. The display shows the absorbance in mAU at the selected wavelength.

DAD-3000RS				
1:	0.234	@ 220 nm	2:	1.234 @ 254 nm
		mAU		mAU
3:	1.456	@ 272 nm	4:	2.416 @ 520 nm
		mAU		mAU
10 Hz	UV: On	VIS: On	2.31	Acquisition

Fig. 27: Data acquisition screen (examples)

The status screen shows the following information:

- Measuring wavelength
- Measured value
- Data collection rate, lamp status, retention time

5.5.5 Detecting Liquid Leaks in the Detector

Leak detection is enabled as a standard when the detector is shipped. When leak detection is active and the leak sensor reports a leak

- The **Status** LED on the front panel door is red.
- A message appears in Chromeleon and on the detector display.
- The **Leak** property in Chromeleon is set to **Leak**.
- A beep alerts you.

When the leak sensor reports a leak, eliminate the cause for the leakage and dry the leak sensor (→ page 115). If the leak is not eliminated immediately, Chromeleon aborts the running batch.

You may disable leak detection permanently. (However, it is not recommended to do so.)

In Chromeleon, open the **Commands** dialog box for the detector and set **LeakSensorMode** to **Disabled**.

5.5.6 Adjusting the Screen Brightness or Contrast

You can adjust the screen brightness or screen contrast to your requirements from Chromeleon or on the front panel display.

To adjust the settings from Chromeleon

1. Open the **Commands** dialog box for the detector.
2. Select **Brightness** and change the value for the screen brightness as appropriate.
Select **Contrast** and change the value for the screen contrast as appropriate.

To adjust the settings on the front panel display

1. Show the function keys and select **Menu**.
2. Select the **Configuration** menu and select **Display & soft keys**.
3. Select **Brightness** and change the value for the screen brightness as appropriate.
Select **Contrast** and change the value for the screen contrast as appropriate.

5.6 Special Functions in Chromeleon

This section provides a short overview of some special functions that Chromeleon supports for the detector.

To learn more about ...	See page ...
Optimizing Detector Performance	See below.
SmartStartup and SmartShutdown	75
Predictive performance	75
Recording the lamp house temperature	76
Diagnostics Tests	77
Operational Qualification and Performance Qualification	77

All of these functions are available in the **Commands** dialog box (unless otherwise noted). In addition, some functions are available also on the control panel for the detector. For additional information about a function, see the Chromeleon Help.

5.6.1 Optimizing Detector Performance

The performance of the detector can be optimized by careful selection of key operating parameters. The table summarizes these parameters, indicates the performance characteristics affected, and offers guidelines for selecting the parameters. For more information, see the Chromeleon Help.

Operating Parameter	Performance Characteristics Affected	Selection Guidelines
Data Collection Rate	Peak resolution and disk space	→ page 70
Response Time	Sensitivity, baseline noise, peak width	→ page 71
Wavelength	Sensitivity and linearity	→ page 71
Bandwidth	Baseline noise	→ page 72
Reference Wavelength	Baseline drift	→ page 72
Reference Bandwidth	Baseline noise and baseline drift	→ page 73
Slit Width	Baseline noise, spectral resolution, peak match	→ page 74
Bunch Width (3D-Feld)	Spectral resolution, peak match, disk space	→ page 74

In Chromeleon, you can set the operating parameters manually in the **Commands** dialog box for the detector (→ page 52) and on the page for the detectors of the **Panel Tabset** (→ page 53).

When you create a program with the Program Wizard, the wizard automatically calculates the data collection rate and an appropriate response time, based on the value you enter for peak width at half-height.

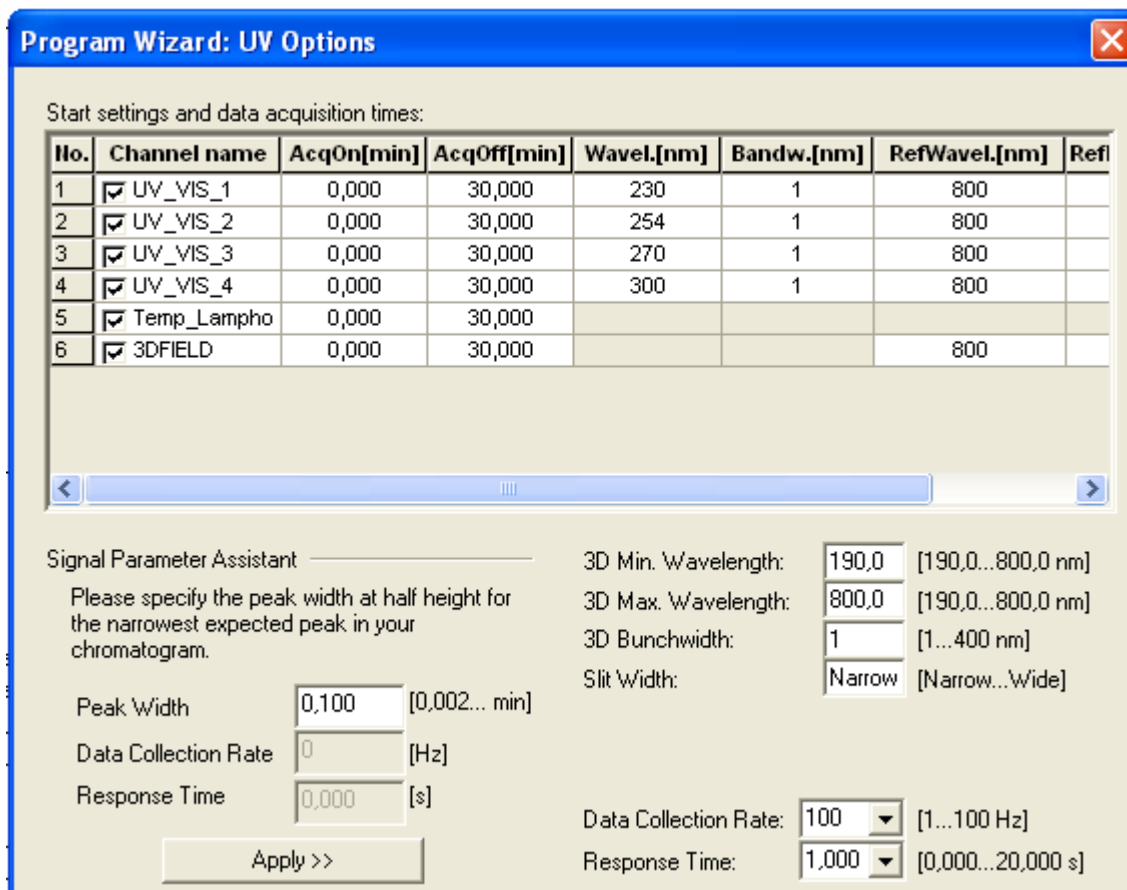

Fig. 28: UV Options page in the program wizard

5.6.1.1 Data Collection Rate

The data collection rate is the number of data points per second (Hz) that Chromeleon collects from the detector and stores as raw data. The maximum number of data points per second generated by the detector electronics depends on the detector version and the Chromeleon version. Data can be generated with a maximum collection rate of 100 Hz; when the DAD-3000RS or MWD-3000RS is operated from Chromeleon 7.1 or later, data can be generated with a maximum collection rate of 200 Hz.

- In general, each peak should be defined by at least 20 data points. This is especially required to achieve a good peak area precision. For chromatograms with co-eluting peaks or low signal-to-noise ratios, 40 data points per peak is recommended.
- If all peaks are relatively wide, select a slower data collection rate (for example, 1.0 Hz).
- If any peaks of interest are less than a few seconds, select a faster data collection rate (for example, 10.0 Hz).

- If the data collection rate is too slow, the start and end points of peaks are not accurately determined. If the collection rate is too fast, data files may occupy excessive disk space and post-run analyses may require more processing time.
- In multiple wavelength applications, baseline noise increases at higher data collection rates. This is especially the case of the data rate is set to the maximum or close to the maximum. To reduce noise, select a lower data collection rate.
- The data collection rate and response time settings should always be considered and set together to optimize the amount of data points collected and reduce short-term noise, while still maintaining peak height, symmetry, and resolution.
- The Program Wizard in Chromeleon automatically calculates the response time (and appropriate data collection rate), based on the value you enter for peak width at half-height (→ Fig. 28, page 70).

5.6.1.2 Response Time

The response time is a measure of how quickly the detector responds to a change in signal.

Select a response that is about 10% of the peak width at half-height of the narrowest peak of interest. A longer response time allows more averaging of the signal and results in less short-term noise. However, if the selected response time is too long, this can result in reduced peak heights and asymmetrical peak shapes. When set correctly, the response time significantly reduces baseline noise, but reduces peak height only slightly.

The Program Wizard in Chromeleon automatically calculates the response time (and appropriate data collection rate), based on the value you enter for peak width at half-height (→ Fig. 28, page 70).

5.6.1.3 Wavelength

Set the wavelength for recording the signal on the **UV_VIS** channel to the wavelength with the absorbance maxima for the analytes of interest. For a list of the UV absorbance wavelengths of common chromophores, see Table 2 in section 10 (→ page 128).

5.6.1.4 Bandwidth

The Bandwidth specifies the optical bandwidth at which a chromatogram (UV_VIS channel) is recorded. In general, this corresponds to the optical resolution of a detector.

You can set a wider bandwidth by averaging several single photodiode signals. This process is known as Photodiode Bunching. Averaging is performed symmetrically to the selected wavelength. Thus, at a bandwidth of 31 nm and a wavelength of 255 nm, the signals of all photodiodes between 240 and 270 nm are averaged.

Changing the bandwidth can often help to detect smaller amounts of a component. Quadrupling the bandwidth almost halves the noise. However, in this case, linearity usually decreases.

5.6.1.5 RefWavelength

In addition to the absorption of the sample that is measured, interfering substances can absorb. The absorption of the interfering substances is added to the measured signal from the sample and can lead to errors in the measurement of the sample concentration. The interfering absorption is frequently caused by a changing absorption of the eluent, for example, or refractive index effects (in particular with separations with gradients).

If the interfering substance absorbs over a wide spectrum range, the effect of the interfering absorption on the measured signal can be reduced mathematically. For this purpose, the absorption is measured at the measurement wavelength and at the same time at a reference wavelength (RefWavelength) over a period of time. To correct the signal, the absorption at the reference wavelength is deducted from the absorption at the measurement wavelength.

To reduce the interference effectively, select the reference wavelength so that

- the absorption of the interfering substance is approximately the same at the measurement wavelength and at the reference wavelength.
- the sample that is measured at the reference wavelength does not absorb.
- no other substances (e.g. co-eluting sample components) absorb at the reference wavelength.
- the measurement wavelength and the reference wavelength are approximately in the same spectrum range of the lamp. If you use both lamps, the two wavelengths should either be below 400 nm or above 350 nm.

If the height of the interfering absorption differs between the measurement wavelength and the reference wavelength, the interference is insufficiently compensated or overcompensated. If the sample also absorbs in the spectrum range of the reference wavelength, the measured peak height and peak area are reduced. The absorption of additional substances at the reference wavelength can lead to negative peaks in the measurement channel.

You can set the reference wavelength and the 3D field separately for each channel. If you set the RefWavelength function to **Off** in Chromeleon, the signal correction using the reference wavelength is turned off.

i **Tip:** The use of a reference wavelength can result in additional interference in the chromatogram. Use the reference wavelength carefully and only in special cases. In most cases, measurement without a reference will provide better results.

5.6.1.6 RefBandwidth

The reference bandwidth serves to average several photodiode signals of the Reference Wavelength (also see Bandwidth). It can be selected for each channel separately, including the 3D field. It is not necessary to select a reference bandwidth unless you enter a reference wavelength.

Select a reference bandwidth that is as broad as possible (e.g., 30 - 100 nm) and narrow enough to ensure that the reference range does not to interfere with the absorbance spectrum of the compounds.

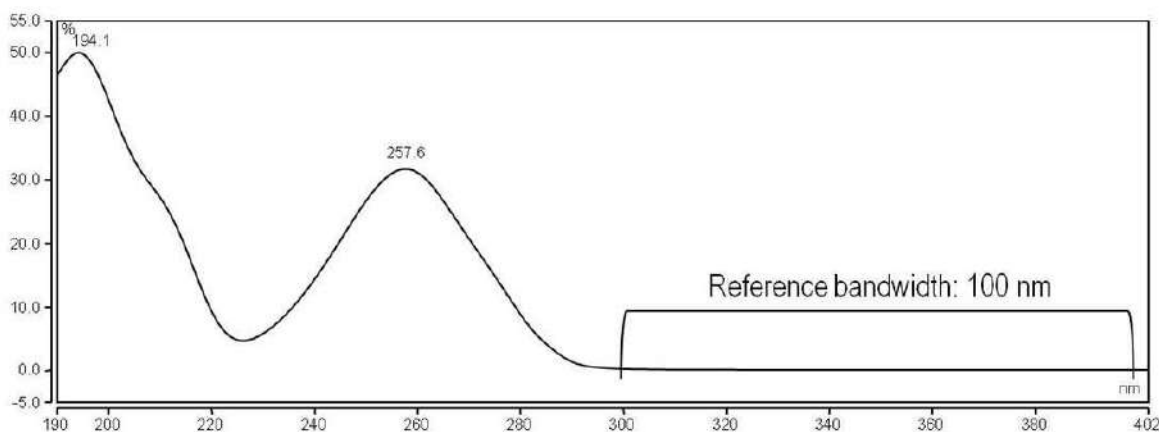

Fig. 29: Example for a chromatogram with reference bandwidth

5.6.1.7 Slit width (MWD-3000RS and DAD-3000RS only)

The detectors in an UltiMate3000 Rapid Separation system are equipped with a variable slit. You can select between two different slit widths: A narrow slit results in a smaller optical bandwidth, but provides a better optical resolution (the ability of the detector to distinguish between single wavelengths), which is required for analytes with fine spectral structures (such as benzene). As more light is available for the measurement, the baseline noise is minimized. However, the optical resolution diminishes.

- Use the wide slit for "normal" applications and for low concentrations.
- Use the narrow slit for high concentrations and for analytes with narrow absorption bands.

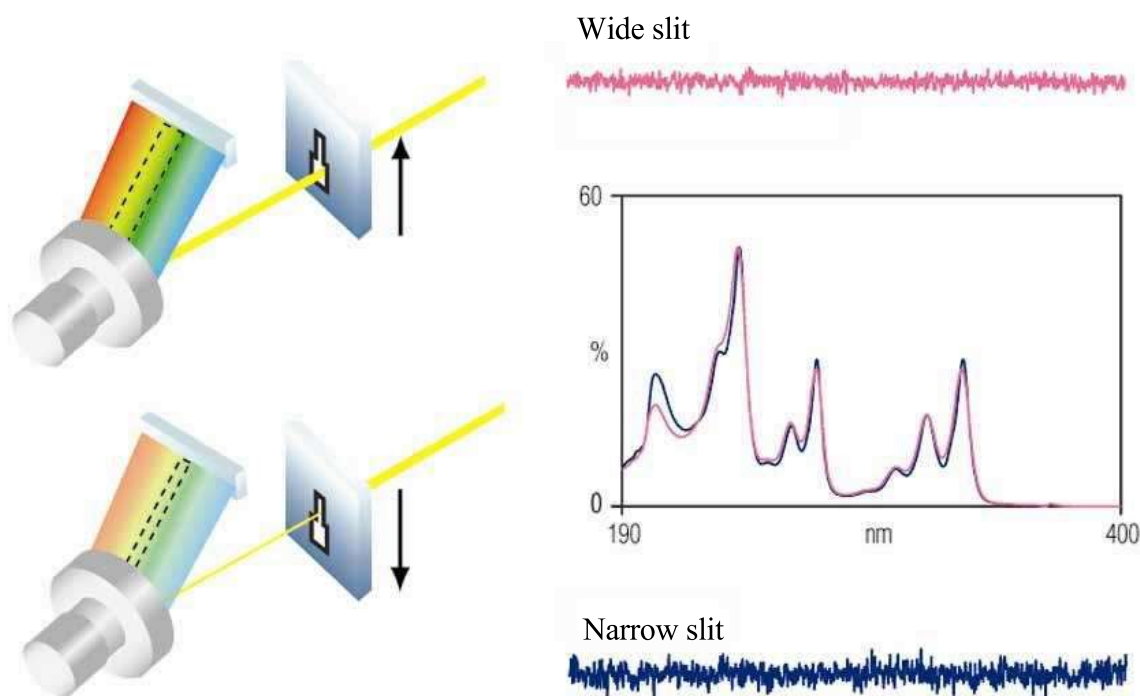

Fig. 30: Effects of the slit width on baseline noise

5.6.1.8 BunchWidth (DAD-3000(RS) only)

The bunch width setting determines the range that is averaged when collecting 3D data (analogous to the Bandwidth of a UV_VIS channel). Selecting a higher BunchWidth will reduce the required data storage and improve the signal-noise-ratio, but will also reduce the spectral resolution.

5.6.2 SmartStartup and SmartShutdown

The **SmartStartup** wizard assists you in automating regular routine tasks (→ page 46). With SmartStartup, the different modules of the UltiMate 3000 system are turned on automatically and in a controlled manner. For the detector, for example, SmartStartup turns the lamps on. In addition, SmartStartup can purge the pump of the HPLC system automatically, flush the column, and perform system equilibration. Important module parameters are monitored. When the modules operate within these limits, the sample sequence, which was set up before, can be started automatically. SmartStartup can be used at any time.

If you have to interrupt system operation, use the SmartShutdown wizard to create a program to set the HPLC system into standby mode or to automate shutdown of the system (→ page 79).

5.6.3 Predictive Performance

Predictive Performance provides various functions for estimating the lifetime of consumables and for monitoring and recording service and (re)qualification information.

Commands Dialog Box

Open the **Commands** dialog box and enter the limits for the predictive performance parameters. For a complete list of available commands and parameters, see the Chromeleon Help. To keep the predictive performance information up-to-date, the following counters are updated automatically after the related component has been exchanged:

After you have replaced the ...	The following counter is updated automatically ...
Deuterium lamp	LastUVLampChangeDate UVLampOperationTime (is reset to the value stored on the lamp chip card)
Tungsten lamp	LastVISLampChangeDate VISLampOperationTime (is reset to the value stored on the lamp chip card)

In addition, Thermo Fisher Scientific recommends the following actions:

After you have ...	Perform the following command ...
Serviced the instrument (for example, annual maintenance)	ServiceDone
Performed instrument qualification	QualificationDone

These commands reset the related counters and update the information when the action was performed.

Control Panel

On the control panel for the detector, click **Wellness**, **Qualification**, and **Service** to see the related predictive performance commands and parameters on separate panels. On these panels, you can enter the limits and reset the counters. In addition, wellness bars provide visual indicators of qualification and service periods.

Color	Description
Green	OK.
Yellow	The value will soon reach the specified limit and/or the related component needs servicing or should be replaced soon.
Orange	(Only for monitoring Qualification properties.) The value has reached the specified limit. However, a Grace Period has been specified during which the component may still be operated.
Red	The value has reached the specified limit. Replacement, servicing, or qualification of the detector is overdue. The detector can no longer be operated. Besides, it is not possible to start a batch.

In addition, a message appears in the Chromeleon Audit Trail when a limit has been reached.

5.6.4 Recording the Lamp House Temperature

On the **Signals** page, the **Temp_Lamphouse** check box is selected by default when the detector is installed and configured in Chromeleon (→ page 40). With this setting, Chromeleon generates the appropriate channel for recording the lamp house temperature. The channel is then available in the **Commands** dialog box for the detector.

The deuterium lamp of the detector is very sensitive to changes in temperature. In case of a long-term drift of the baseline, the lamp house temperature signal can help to find the reason for the problem. Therefore, always record this channel in the Chromeleon program.

5.6.5 Detector Diagnostics

From Service Release 10 on, Chromeleon 6.80 supports Diagnostics functions for checking the performance of the detector and certain detector components.

1. On the **Control** menu, select **Diagnostics**. (The **Control** menu is visible only when a control panel is open.)
2. The **Diagnostics** dialog box lists all tests that are available for the devices in the current timebase. Select a test for the detector. For information about how to run the tests, see the Chromeleon Help.

To ...	Select ...
Perform wavelength verification (quality assurance or suspected wavelength inaccuracy)	Holmium Oxide Test ¹
Check the intensity of the lamps and detect impurities in the flow cell and/or solvent (quality assurance or noisy baseline)	Intensity Test ¹ (with flow cell installed)
Check the intensity of the deuterium and/or tungsten lamp without the influence of the currently installed flow cell and the solvent (quality assurance or noisy baseline)	Intensity Test ² (without flow cell)
Determine the dark current signal (stray light) of the detector in the currently used system (noisy baseline, high drift, poor linearity)	Dark Current Test ¹ (with flow cell installed)
Determine the dark current signal (stray light) of the detector without the influence of the currently installed fluidic system (noisy baseline, high drift, poor linearity)	Dark Current Test ² (without flow cell)
Check the mechanism for changing the slit width for correct functioning (DAD-3000RS and MWD-3000RS only) (quality assurance)	Slit Test ¹

¹ For these tests, the pump of the UltiMate 3000 system is required as the tests are run with a flow cell installed. Note that the LPG-3400XRS pump does not support detector diagnostics. Use degassed water (HPLC grade).

² The test is run without a flow cell installed, no pump is required. Remove the flow cell before you start the test.

For this test, you will have to adapt the upper and lower pressure limits. Thus, to avoid damage to the column, Thermo Fisher Scientific recommends replacing the column with a restrictor capillary. (An appropriate capillary is included, for example, in the Diagnostics Tool Kit for the detectors.)

If a test fails, check the 'Diagnostics Tests in Chromeleon' section for recommended courses of action (→ page 85).

5.6.6 Operational Qualification and Performance Qualification

Operational Qualification and Performance Qualification allow you to check and document the performance of the HPLC system. All materials required for performing qualification and detailed instructions are available on request.

5.7 Shutting Down the Detector

Observe the following precautions before interrupting the operation or before shipping the detector:

- Even during periods of detector inactivity, the flow cell cover must be installed. This is to prevent that dust particles cause damage to the detector optics.
- If you want to move or ship the detector, retighten the locks on the bottom of detector to secure the optics during shipment (→ Fig. 7, page 30). Reinstall the cardboard with the notice about the shipping locks that was shipped with the detector. To do so, push the cardboard under the orange shipping locks on the detector bottom as shown and fold the other end of the cardboard around the front panel door.
- Rinse out any solvents from the flow cell, for example, using isopropanol. You can flush the flow cell by using the optional syringe injection/flushing kit (part no. 6078.4200).
- Ship the module only in the original shipping container and observe the packing instructions. Shipping the unit in any other packaging automatically voids the warranty. If the original shipping container is not available, appropriate shipping containers and packing material can be ordered from Thermo Fisher Scientific sales organization for Dionex HPLC products. The packing instructions are included in the "Installation and Qualification Documents for Chromatography Instruments" binder and are also available on request.

If you are running Chromeleon, you can set the detector and HPLC system into the standby mode or automate system shutdown, as described in the sections below.

Standby Program

A standby program sets the HPLC system into standby mode. The application can be reactivated very quickly afterward. The main program steps:

- The pump flow is automatically reduced at the end of the program.
- The temperature of all temperature-controlled modules in the system is reduced.

Shutdown Program

A shutdown program automates shutdown of the HPLC system. The main program steps are:

- The pump flow is automatically stopped at the end of the program.
- Certain system components and functions are turned off (for example, detector lamps, temperature control).

To create a standby or shutdown program

Select one of the following alternatives:

- Select and perform the operating commands and parameters from the **Commands** dialog box.
- Create and run a corresponding program to automate the process (→ page 55).
- Use the SmartShutdown Wizard to create and run the program (see below).

To create the program with the SmartShutdown wizard

1. To open the wizard, click **SmartShutdown** on the **Batch** menu.
2. Follow the instructions as they appear on each page of the wizard. For additional information about a page, click **Help**.
3. After you finish the wizard, Chromeleon
 - ◆ creates the program and saves it in the timebase for which you create the program.
 - ◆ Opens the **Start Batch on** dialog box.

Select the program and click **Start** to run the program.

For more information about the SmartShutdown wizard, see the Chromeleon Help.

5.8 Routine and Preventive Maintenance Intervals

The detector is made of high-quality components and materials to minimize maintenance requirements. All surfaces are well resistant to weak acids, alkali, and organic solvents. Nevertheless, immediately wipe up all liquids spilled onto the detector surface, using lint-free cloth or paper. If surfaces are exposed for longer periods, these liquids can cause damage.

Perform the maintenance procedures listed in the table at regular intervals to ensure optimum performance and maximum uptime of the detector. The exact maintenance schedule for the detector will depend on a number of factors.

Frequency	What you should do...
Daily	Inspect the fluid connections for indications of leakage or restrictions.
	When using buffer solutions, flush the system thoroughly after use. Use a solvent that does not contain buffers or salts
Regularly	Check the drain tube connected to the drain port on the bottom right of the detector (→ page 45). Verify that the tubing is unclogged and is routed below the drain port. Check the volume of the liquid in the waste container and empty as needed.
	Monitor the lamps (→ page 102). Replace the lamps if necessary (→ page 103).
Annually	Have a service representative check the detector once a year to prevent contamination and excessive wear.

i **Tip:** Chromeleon supports functions for estimating the lifetime of consumables and diagnostic tests to check the performance of certain detector components (→ pages 75 and 77).

6 Troubleshooting

6.1 Overview

The following features help you to identify and eliminate the source for problems that may occur during the operation of the detector or UltiMate 3000 system.

Status Screens

The status indicators on the front panel provide a quick visual check of the operational status of the detector. They indicate whether the detector is turned on, connected in Chromeleon, and operating properly (→ page 20).

Error Messages

If a fault or error is detected during the operation of the detector, a message appears on the detector display. Check the 'Messages on the Detector Display' section for recommended courses of action (→ page 82). If the detector is operated by Chromeleon, a message is also displayed in the Chromeleon Audit Trail.

 **Tip:** For information about operating problems that might occur during the operation of an UltiMate 3000 system, see the 'Operating Problems' section (→ page 89).

Diagnostics Tests

If the detector is connected in Chromeleon, Chromeleon provides several diagnostic tests allowing you to check the performance of certain detector components (→ page 77). If a test fails, check the 'Diagnostics Tests in Chromeleon' section for recommended courses of action (→ page 85).

If you are unable to eliminate a problem following the instructions given here, contact Thermo Fisher Scientific Service for Dionex HPLC Products.