

RECURSOS QUE PUEDE OFRECER UN BIORREACTOR

Toque en los números para comenzar.

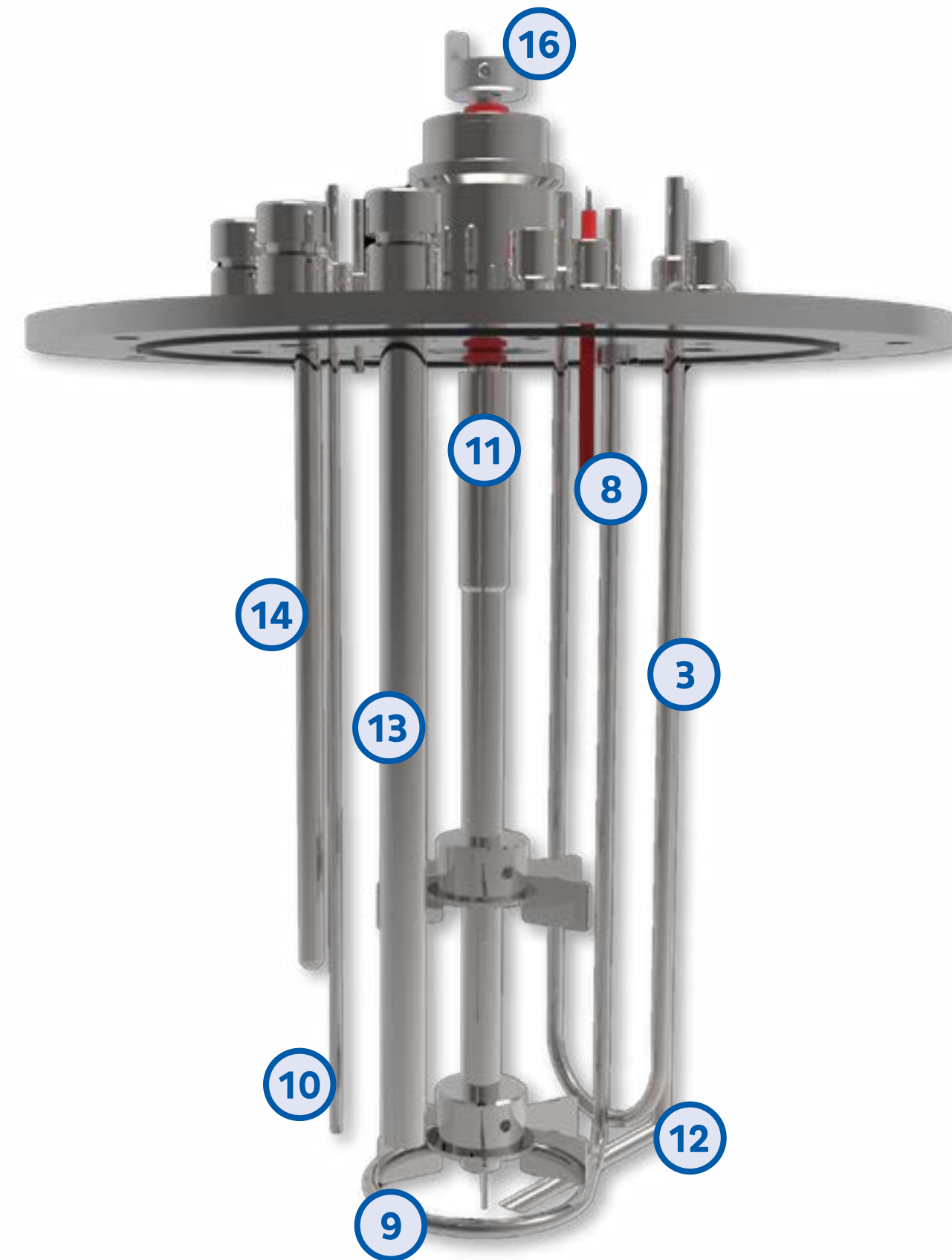
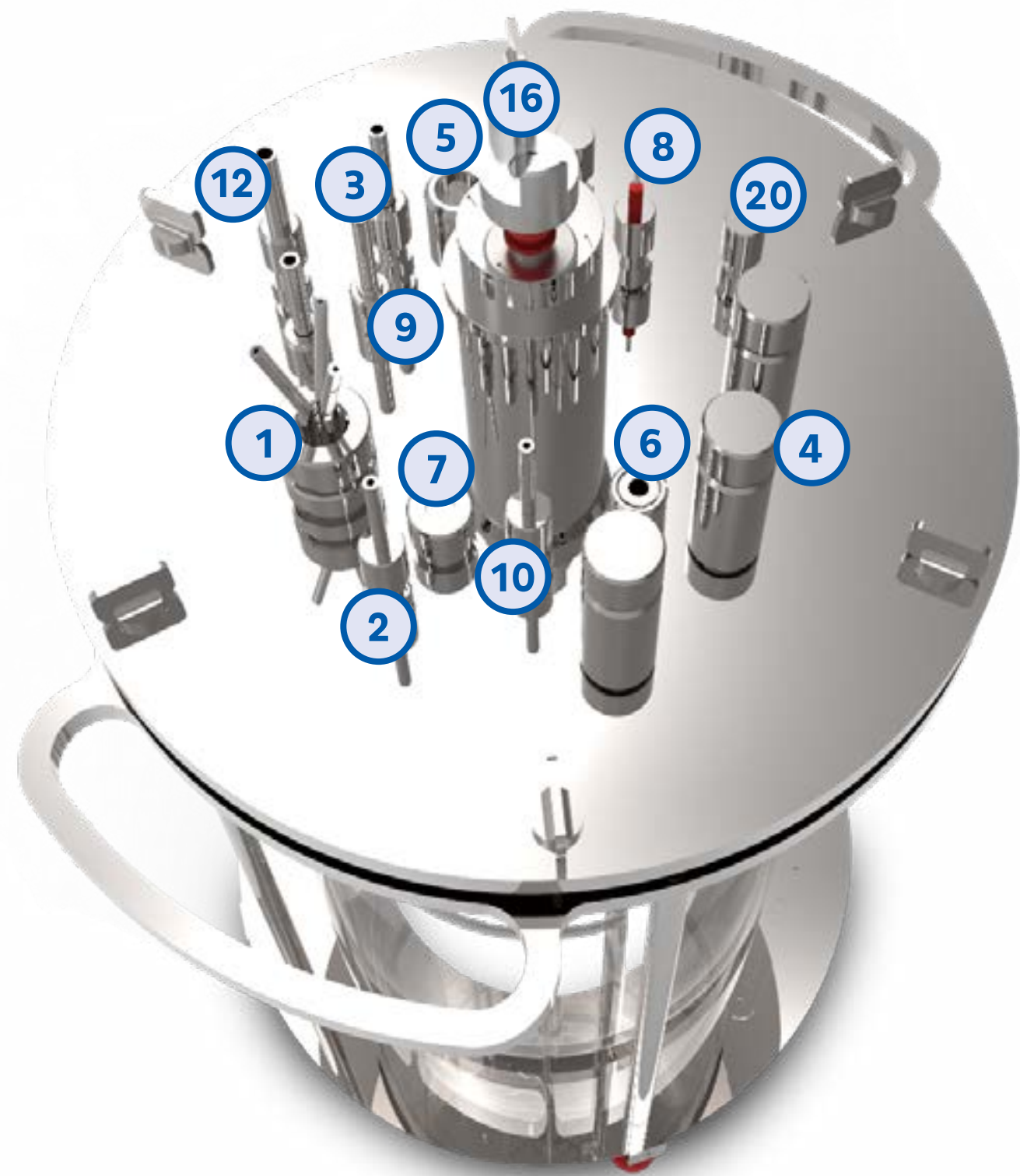

RECURSOS QUE PUEDE OFRECER UN BIORREACTOR

1. Puerta triple (base, nutriente, antiespumante)

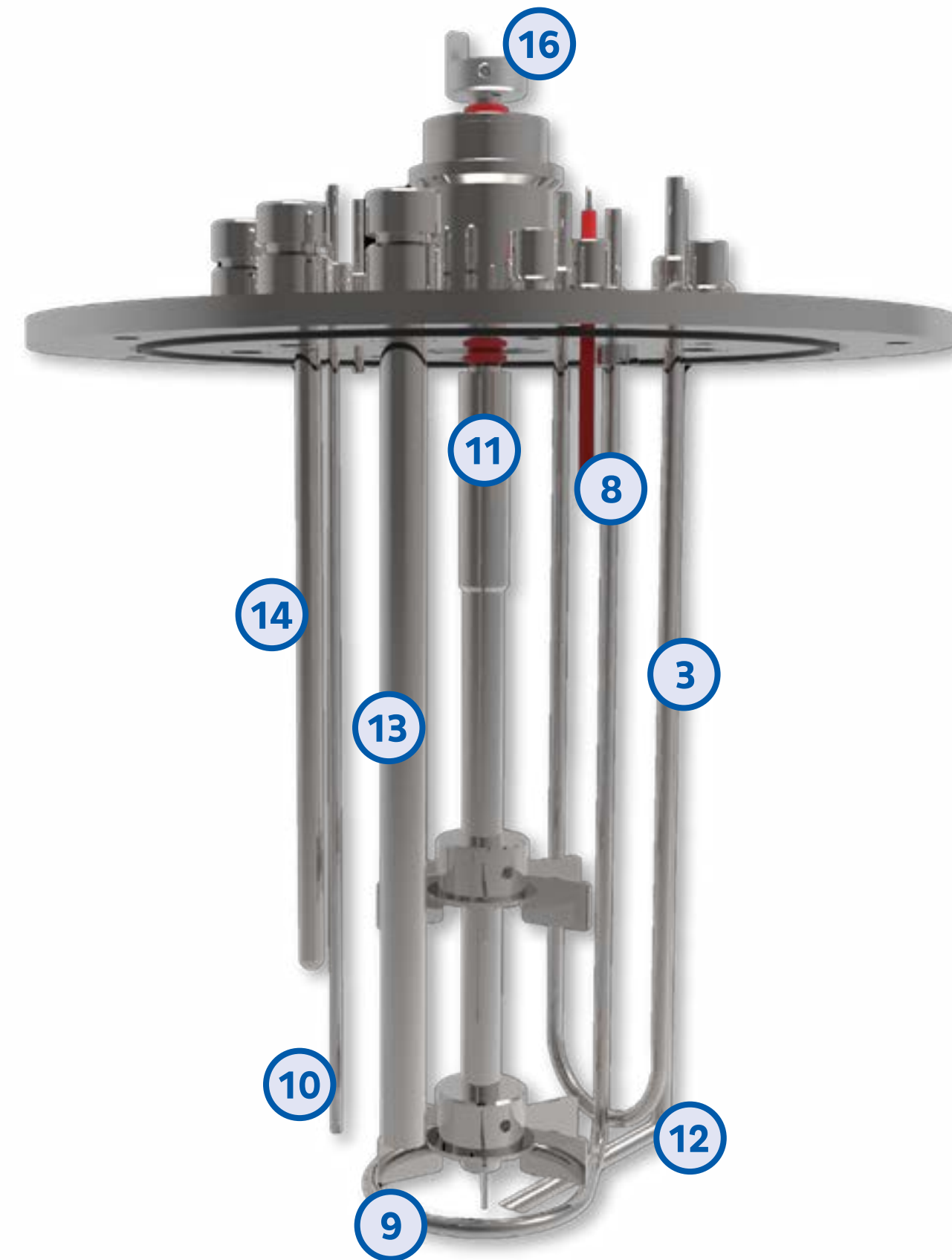
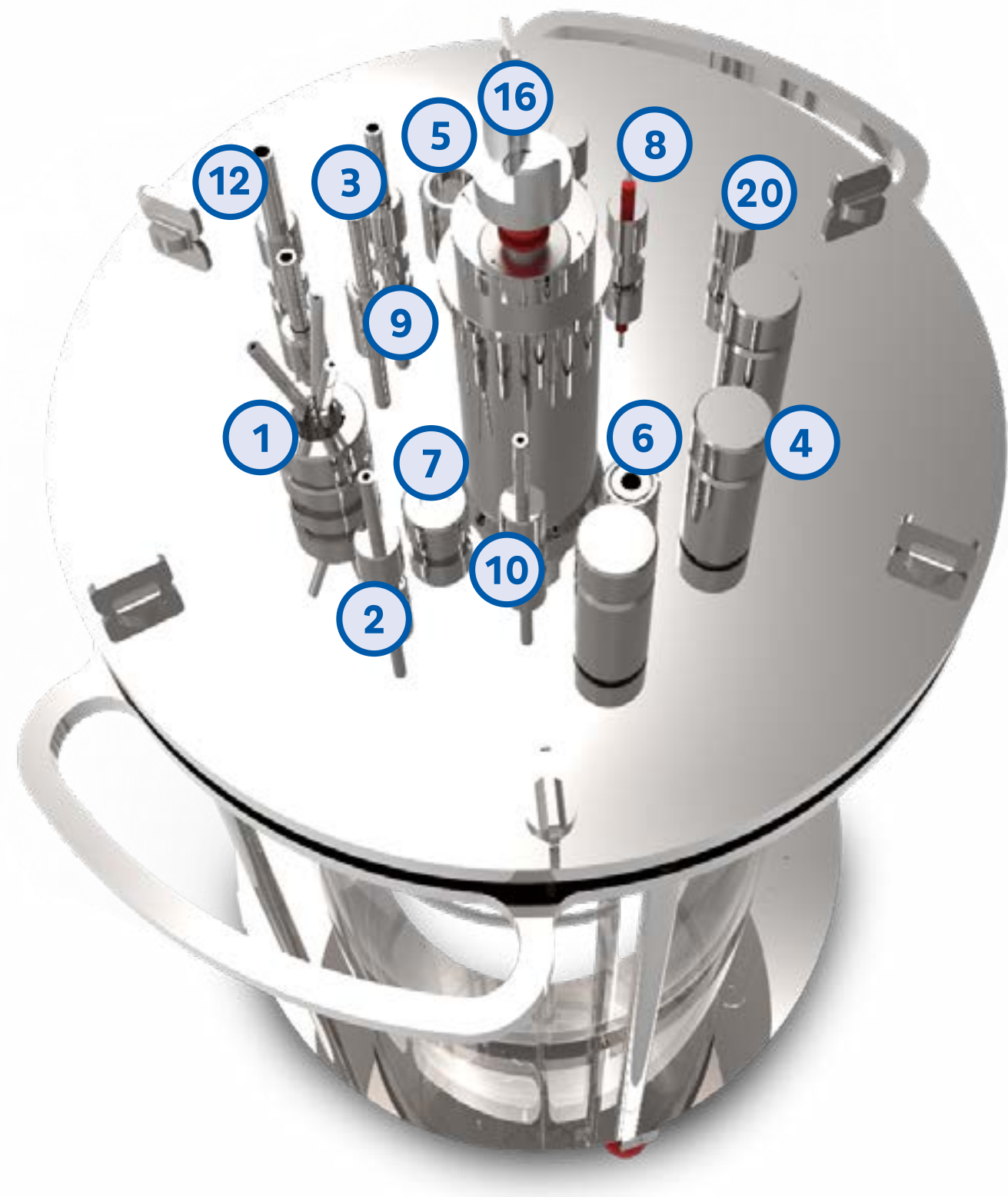

RECURSOS QUE PUEDE OFRECER UN BIORREACTOR

2. Puerta Ácido

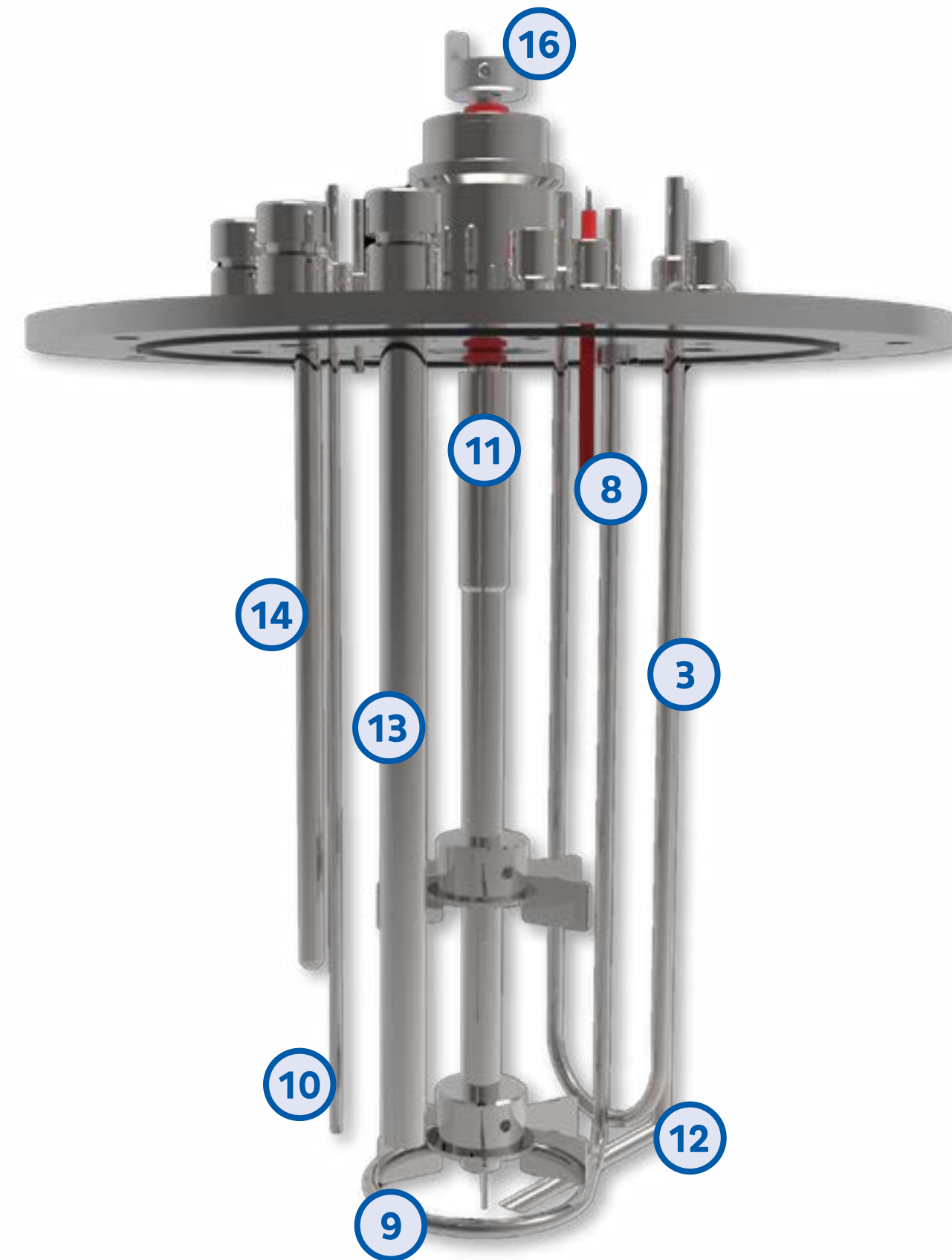
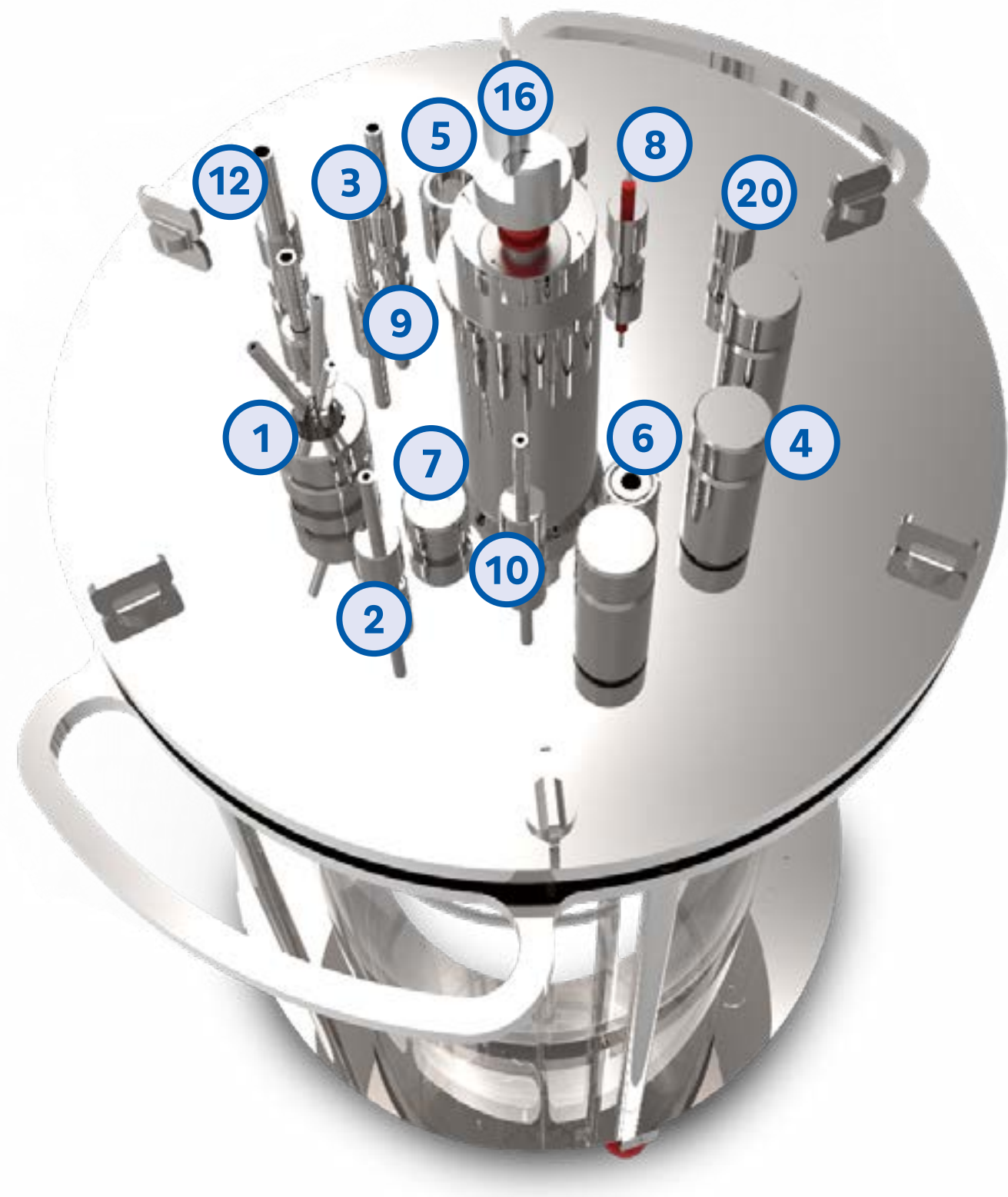

RECURSOS QUE PUEDE OFRECER UN BIORREACTOR

3. Serpentina

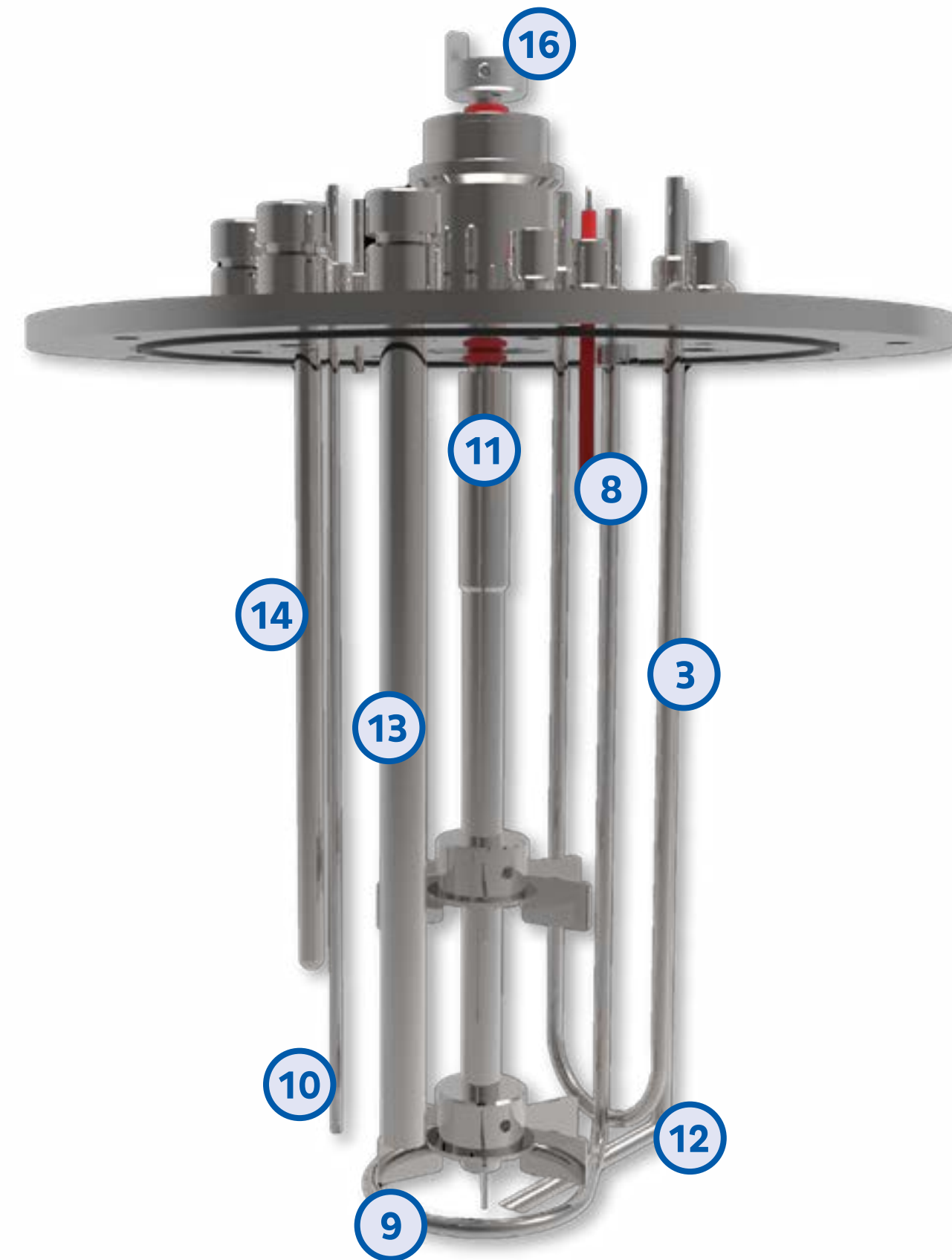
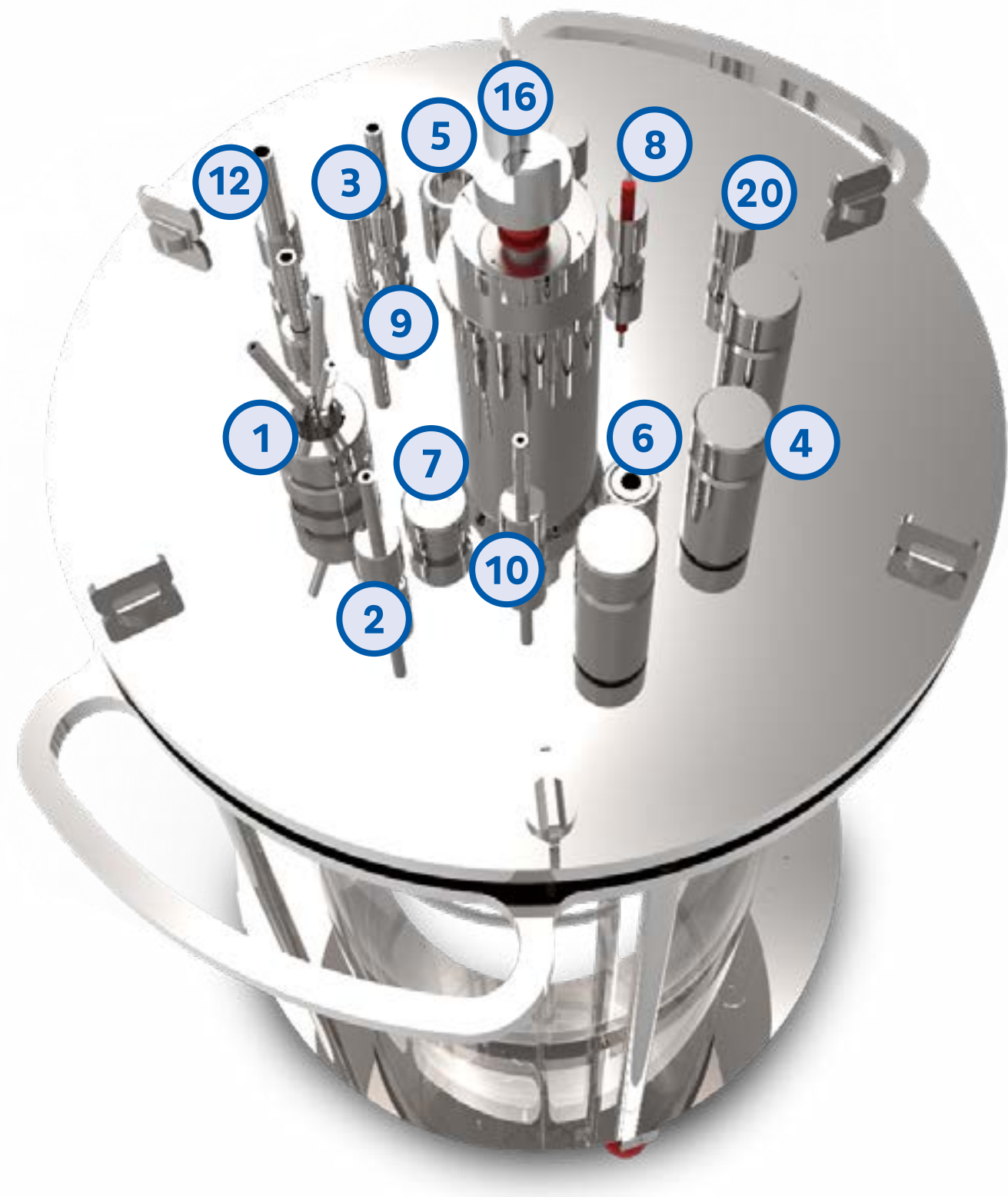

RECURSOS QUE PUEDE OFRECER UN BIORREACTOR

4. Sensores (pH, oxígeno disuelto)

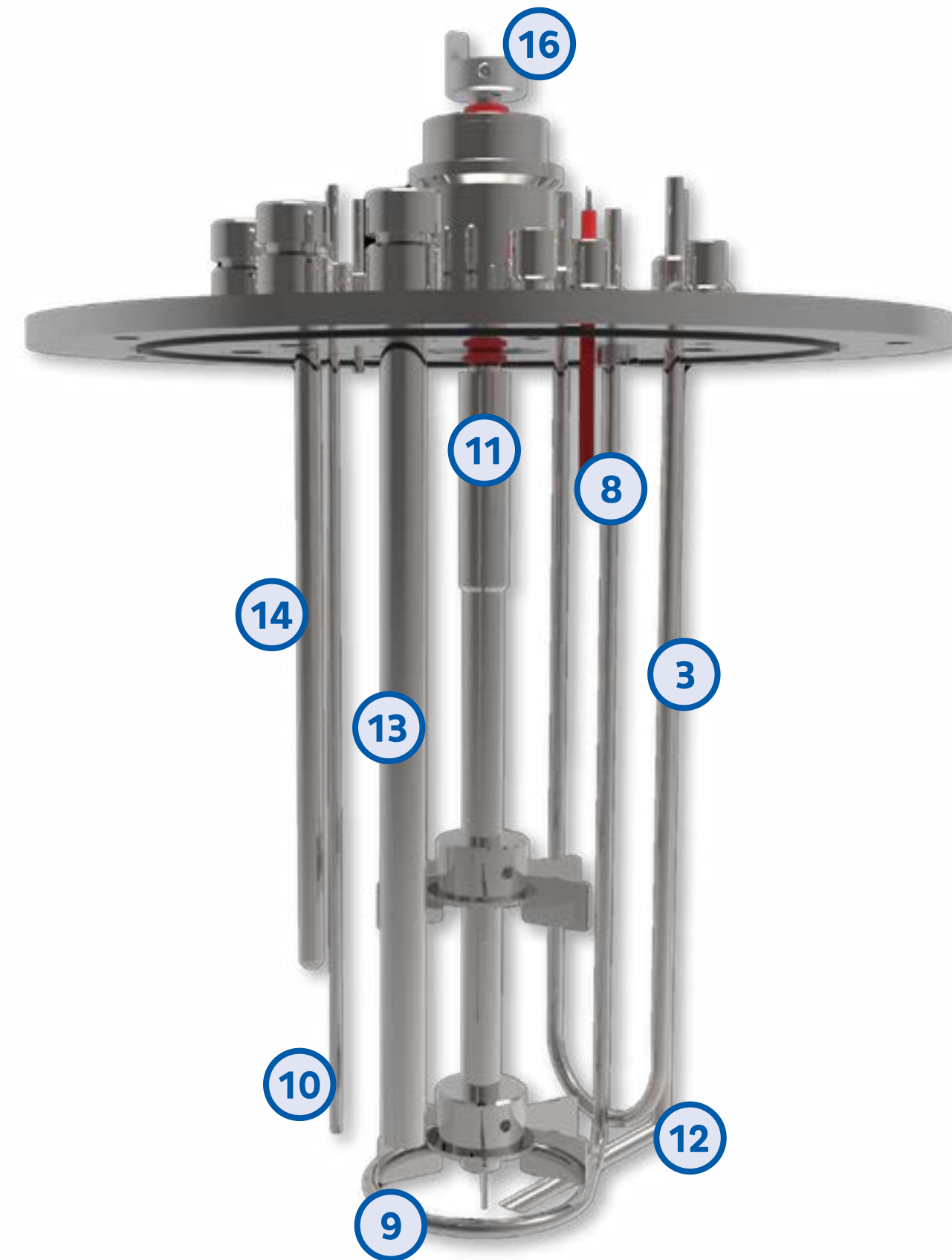
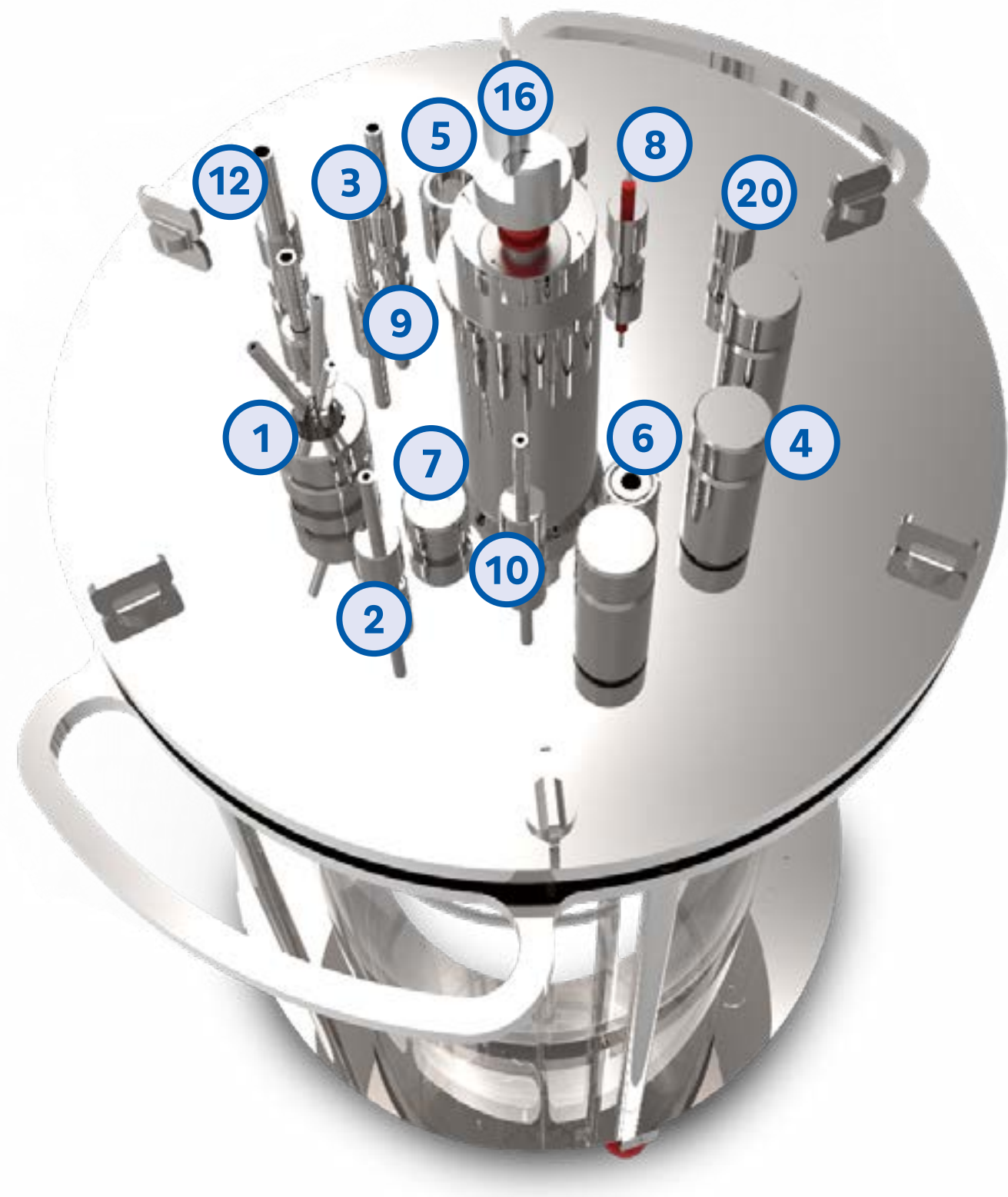

RECURSOS QUE PUEDE OFRECER UN BIORREACTOR

5. Condensador

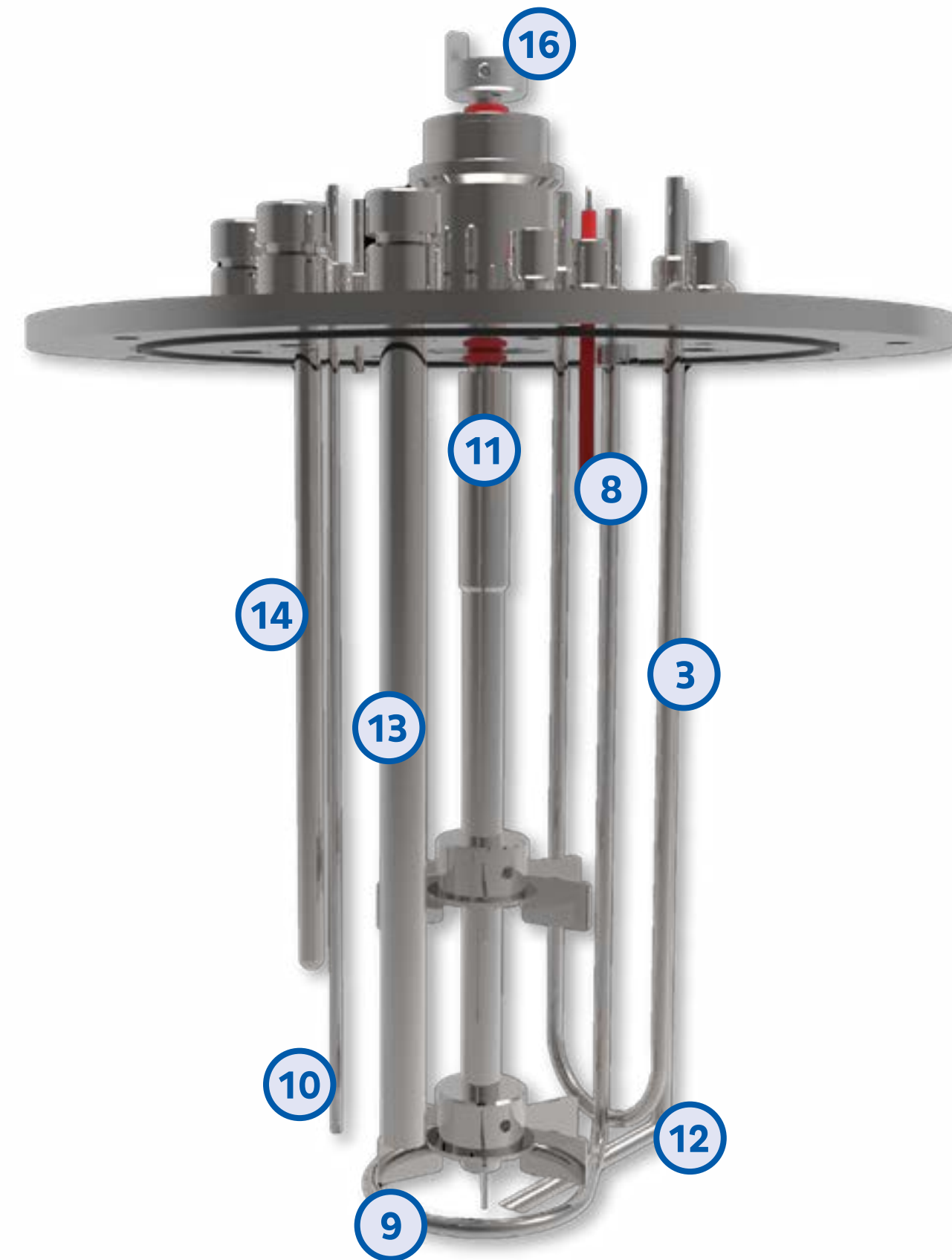
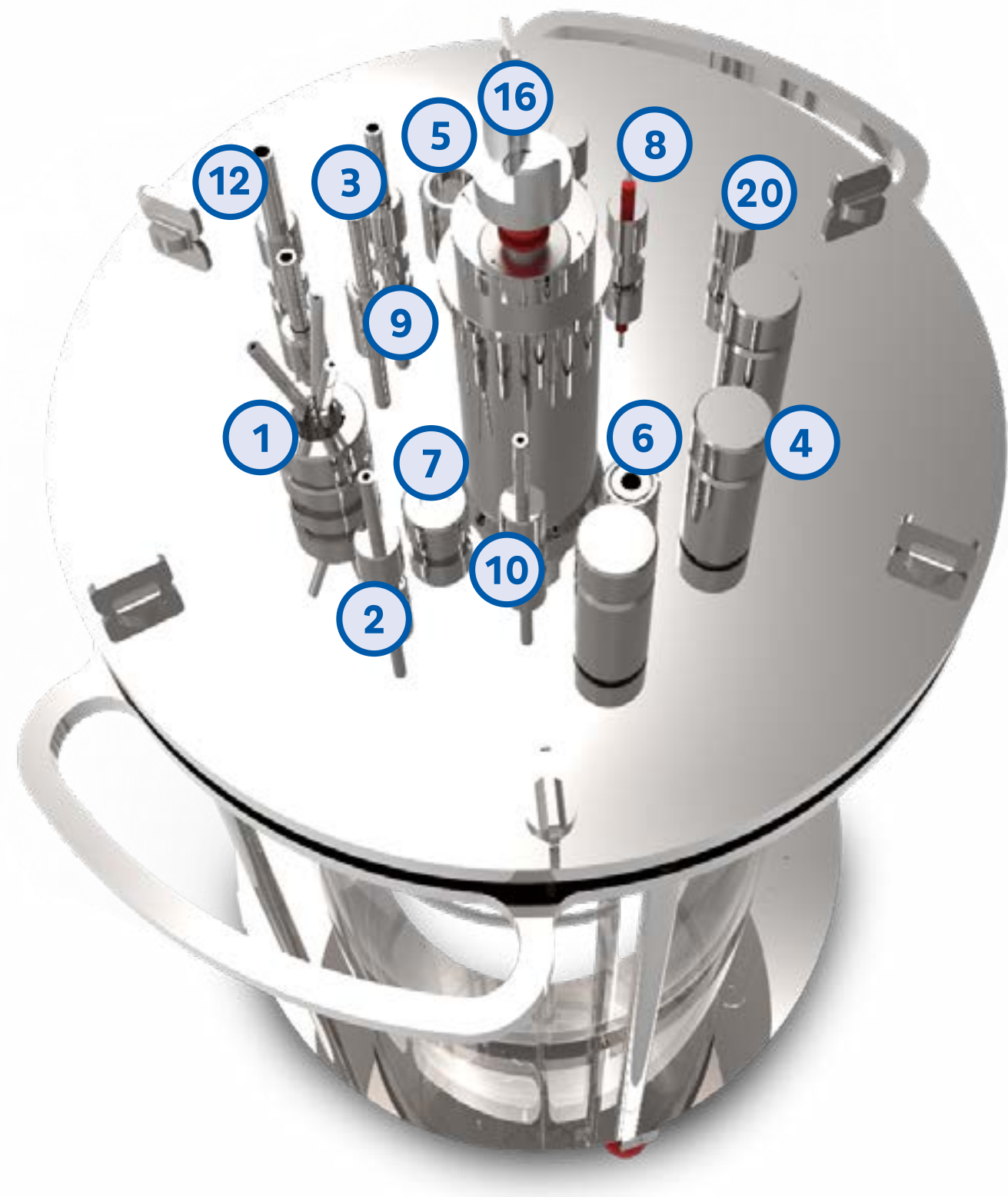

RECURSOS QUE PUEDE OFRECER UN BIORREACTOR

6. Entrada Sensor de Temperatura PT-100

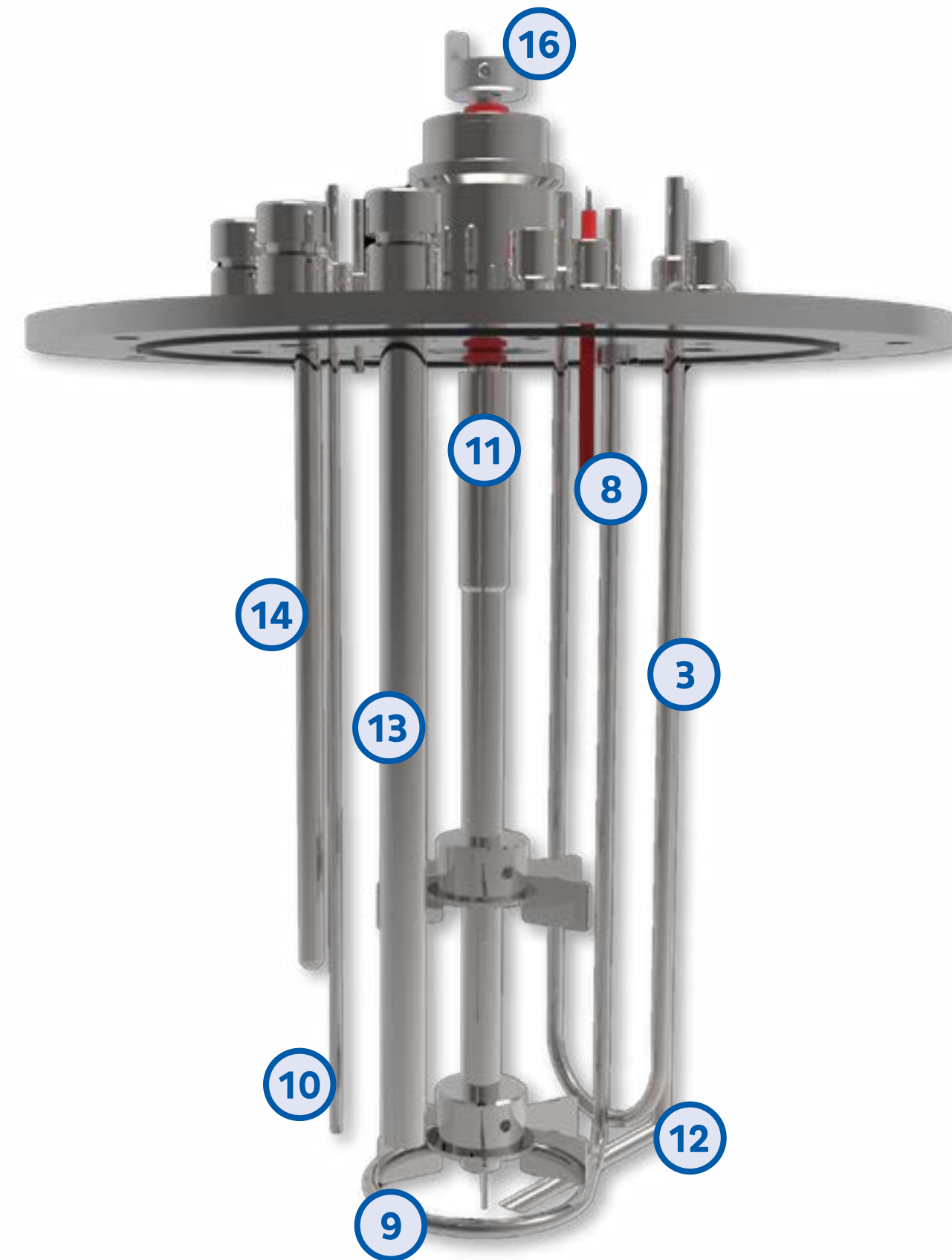
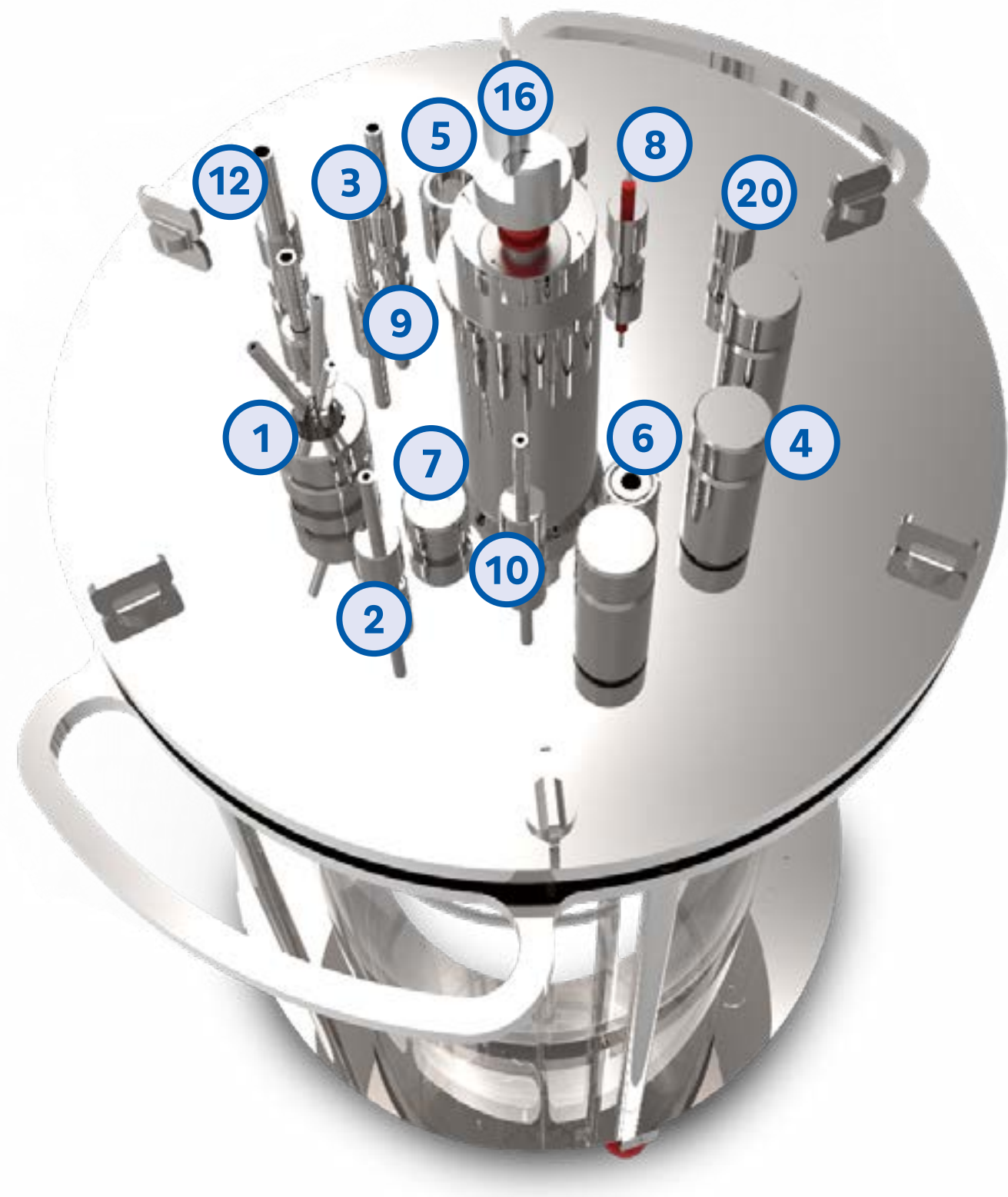

RECURSOS QUE PUEDE OFRECER UN BIORREACTOR

7. Septo

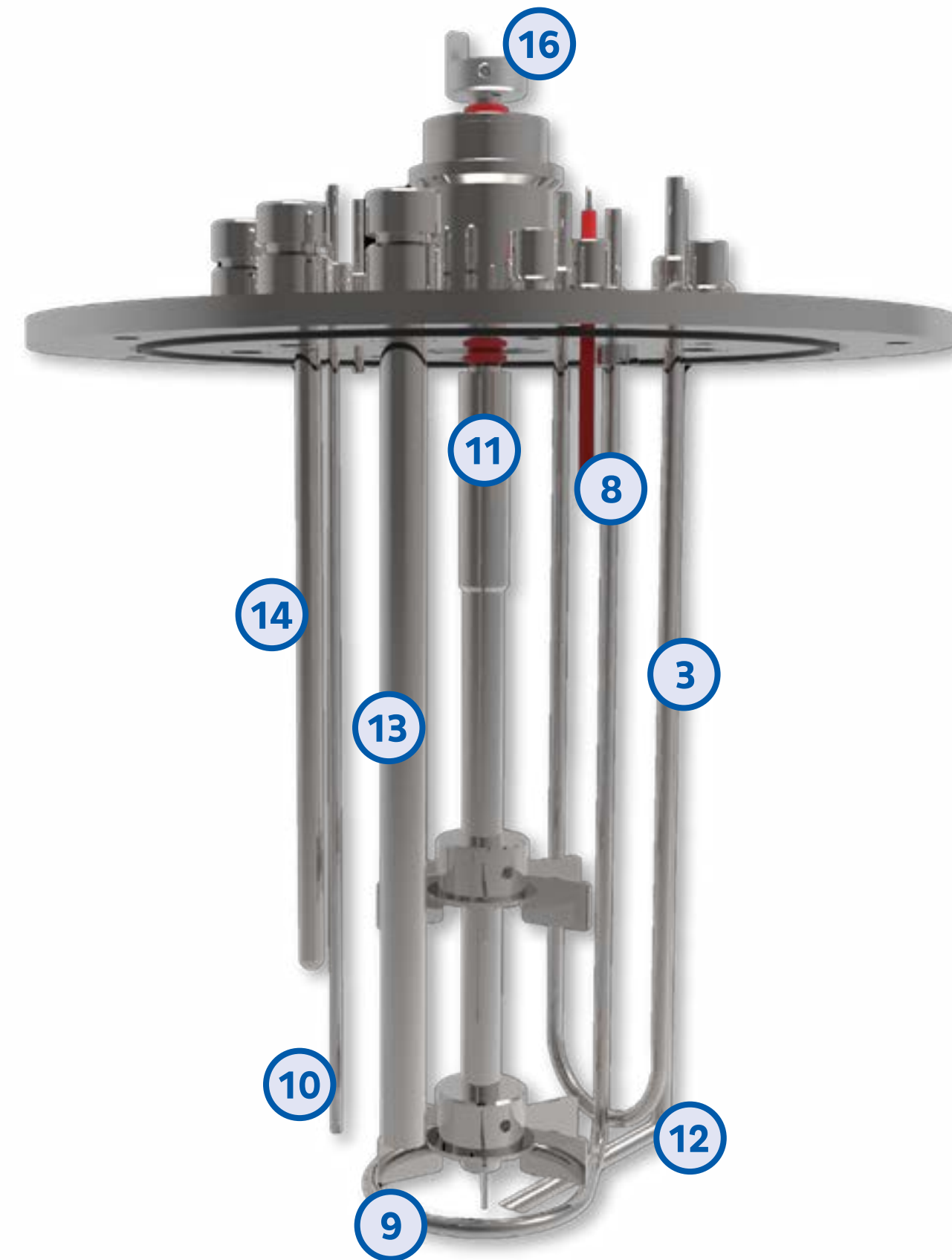
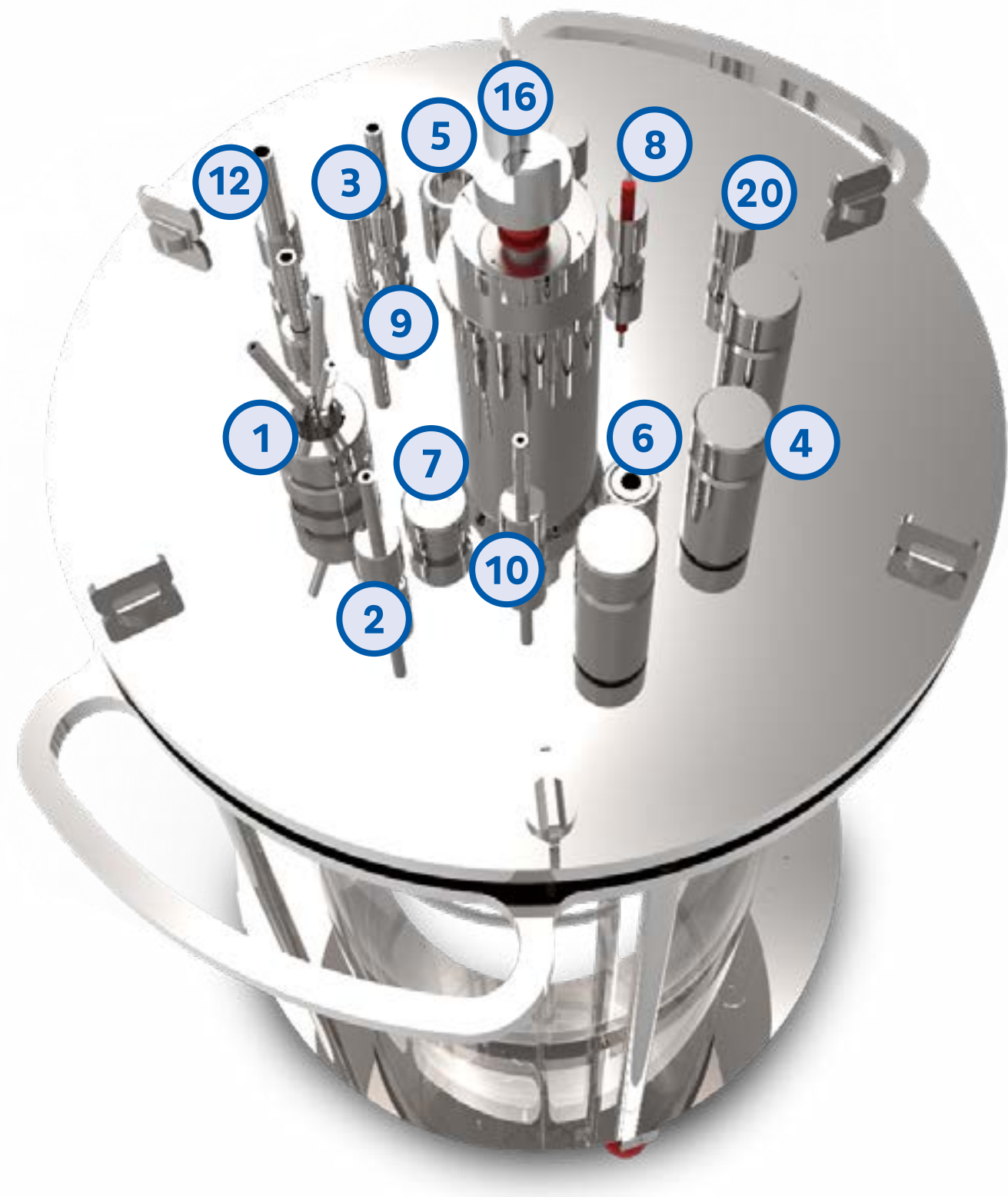

RECURSOS QUE PUEDE OFRECER UN BIORREACTOR

8. Sensor de nivel/Espuma

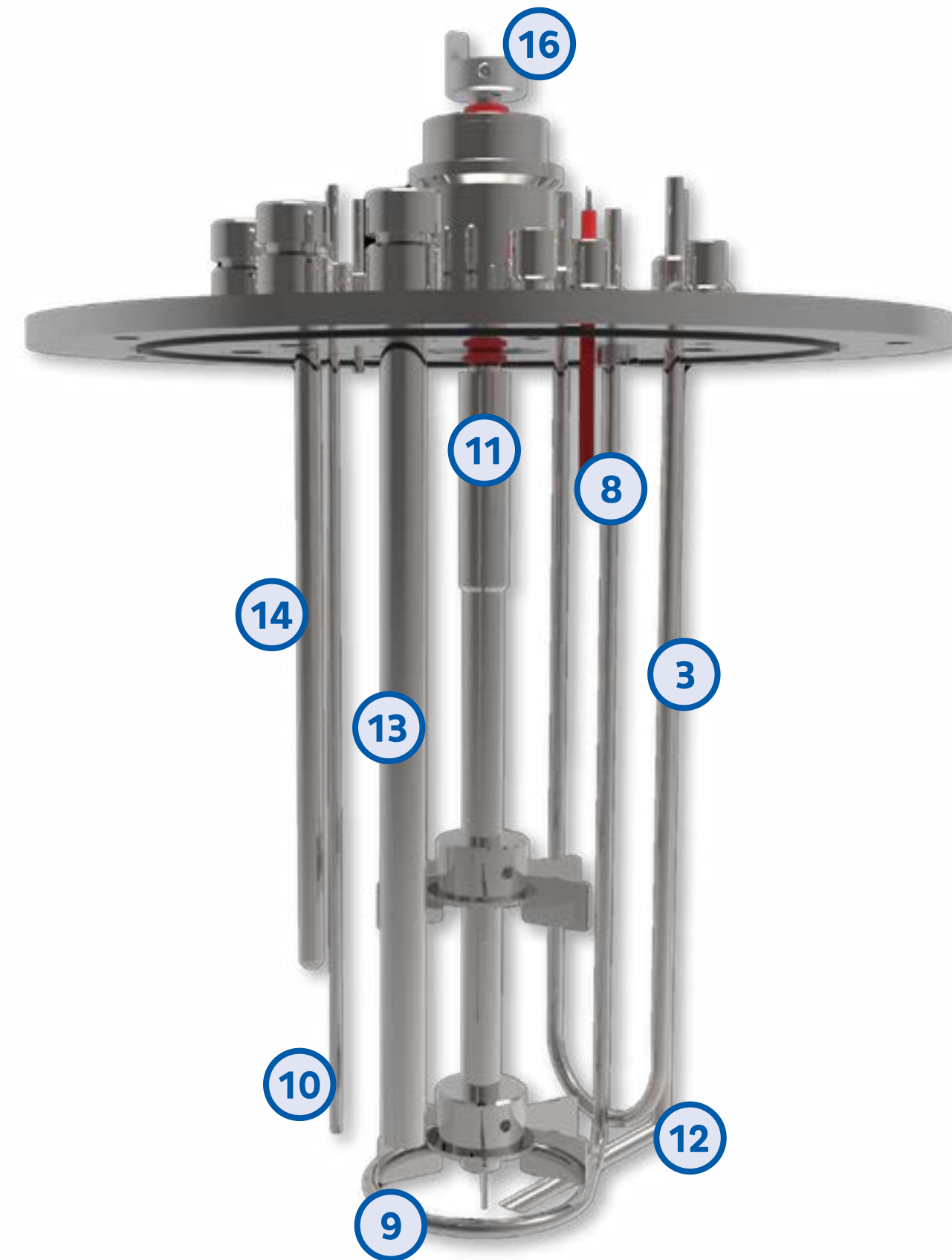
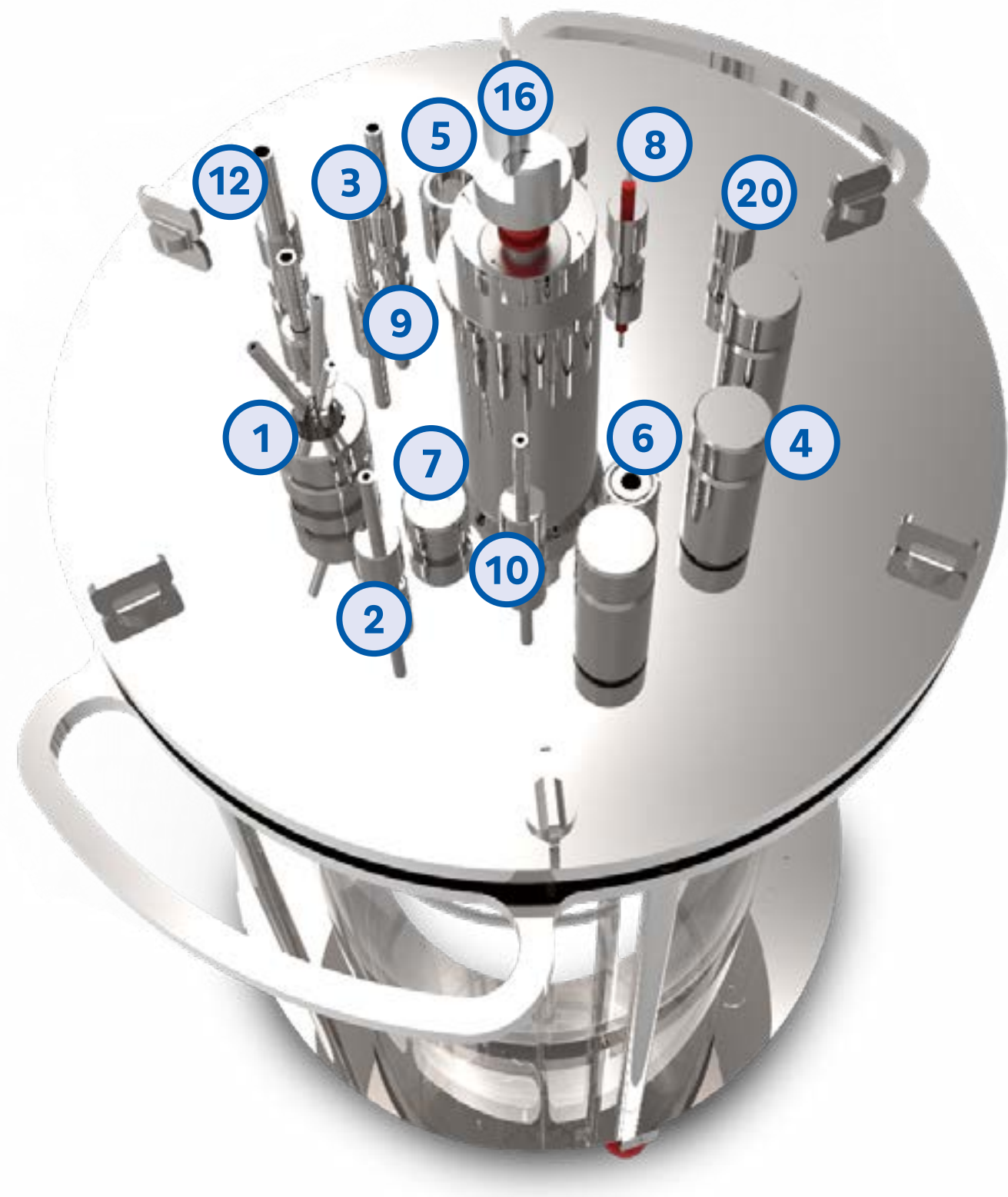

RECURSOS QUE PUEDE OFRECER UN BIORREACTOR

9. Rociador/Aireación

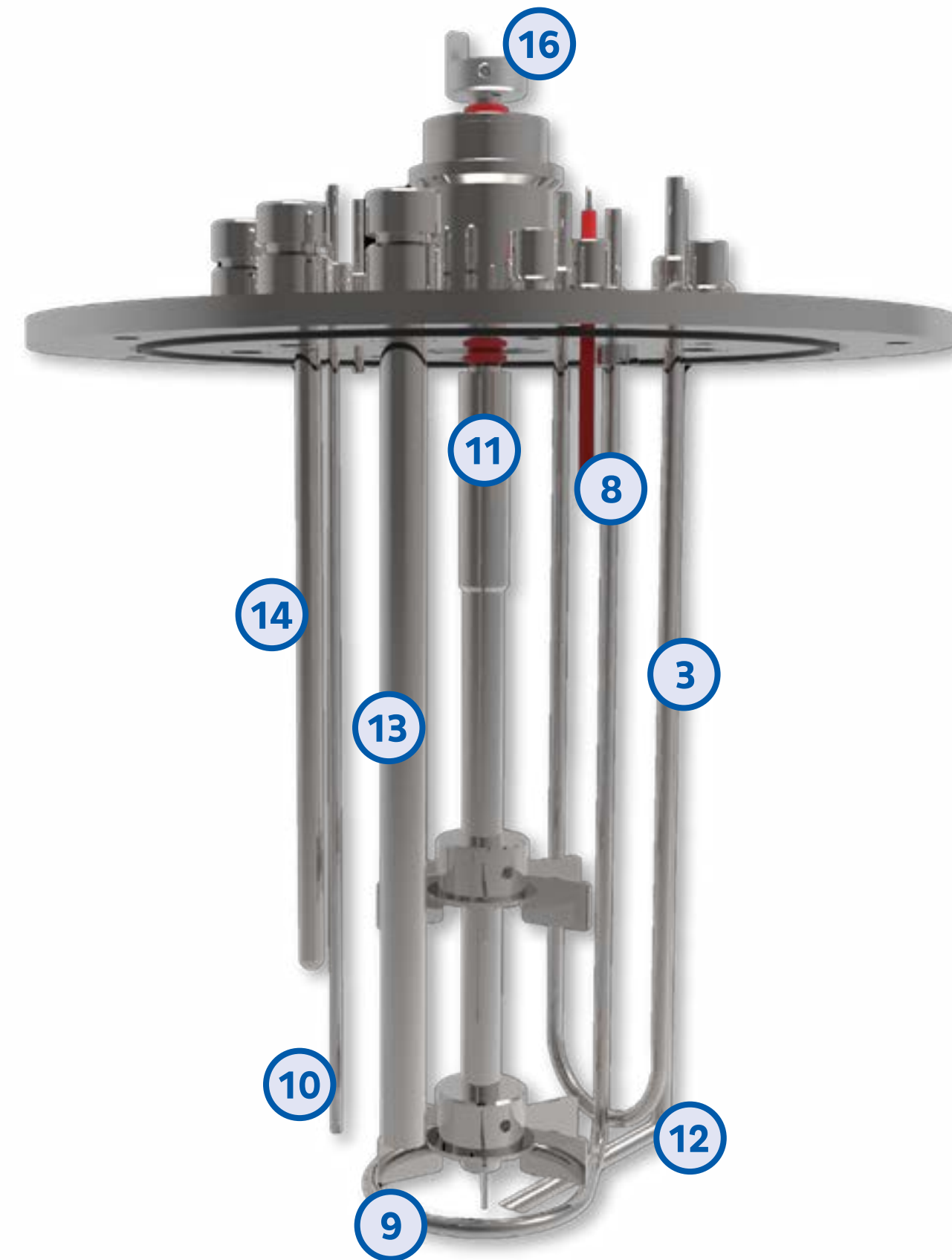
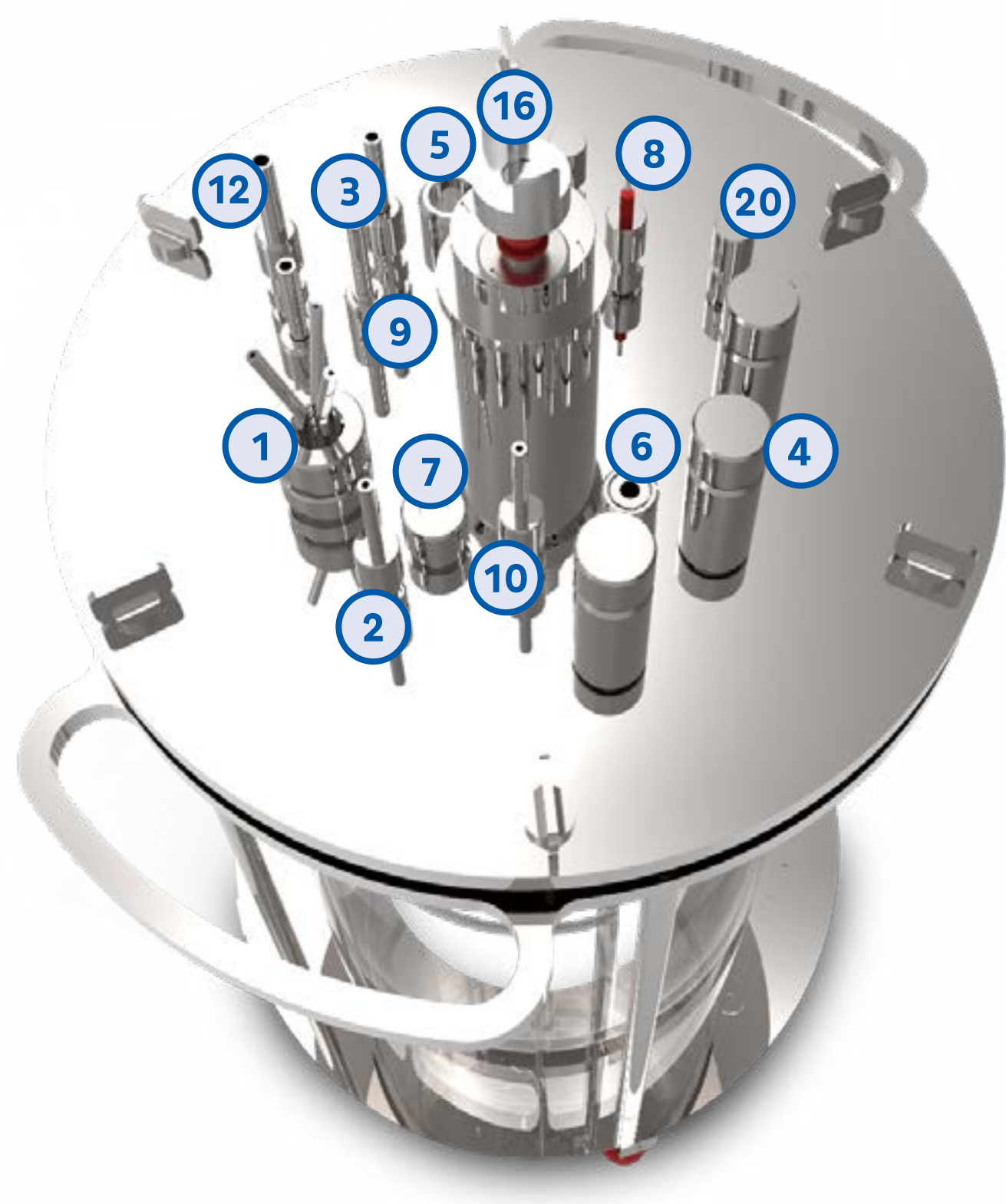

RECURSOS QUE PUEDE OFRECER UN BIORREACTOR

10. Muestreo

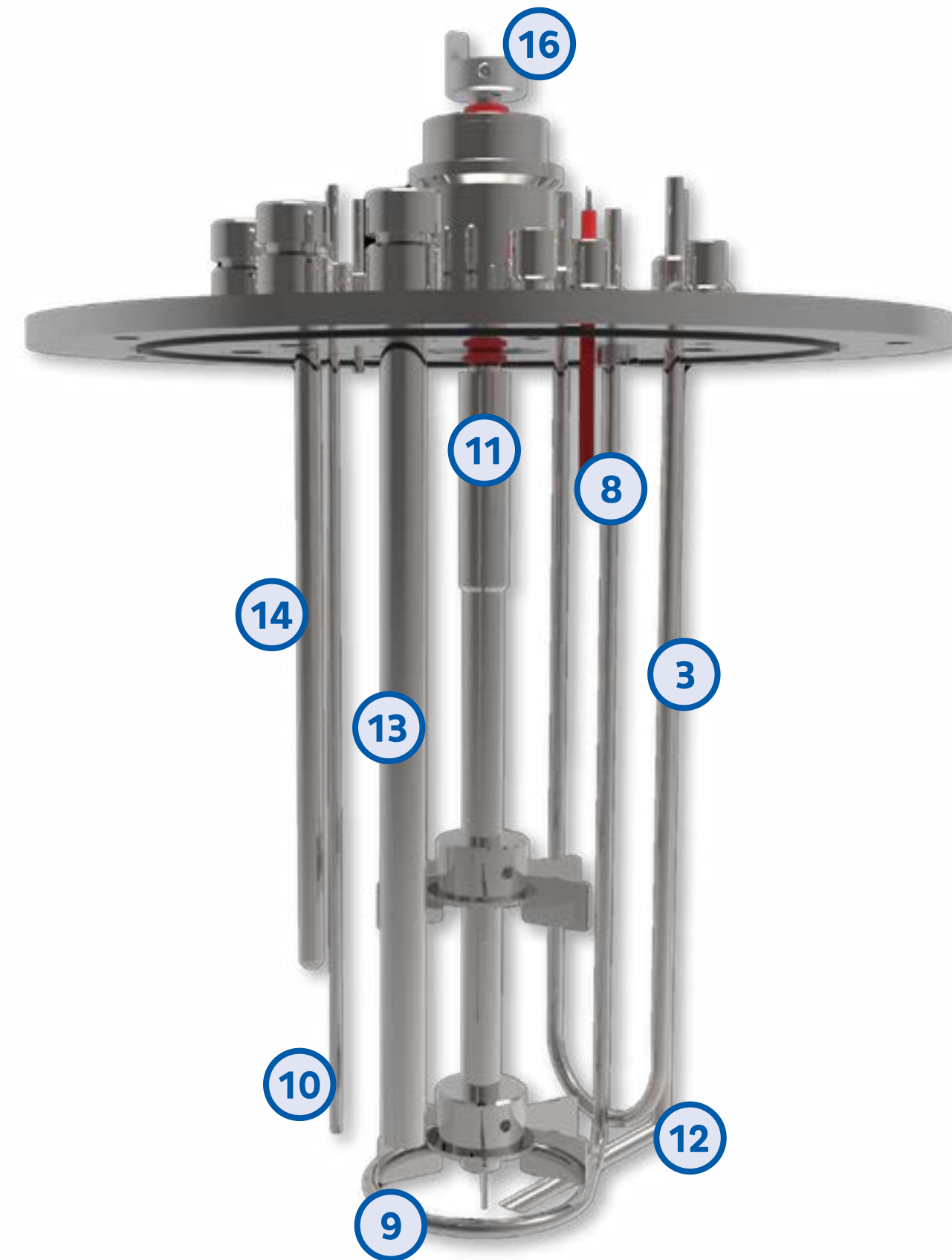
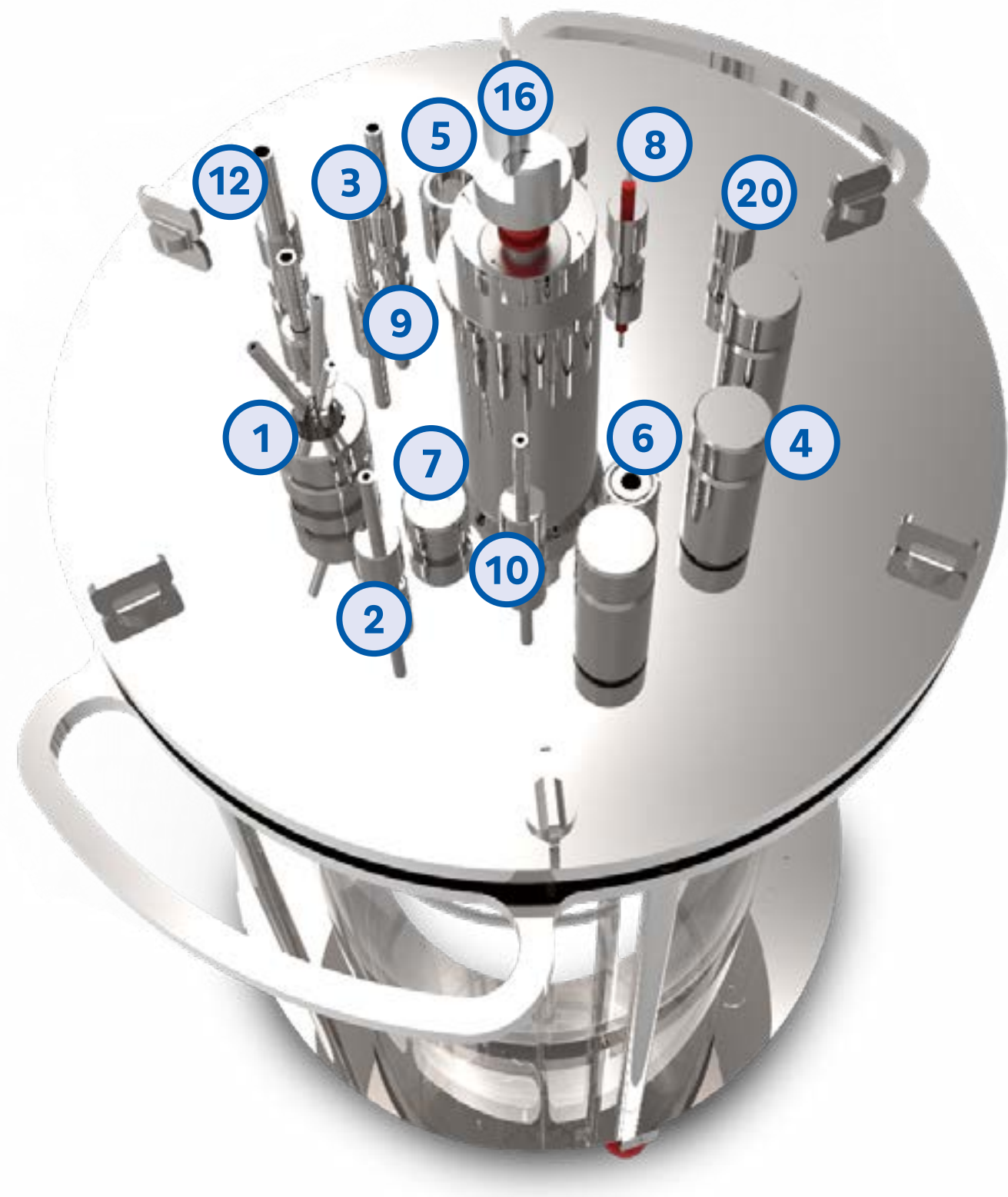

RECURSOS QUE PUEDE OFRECER UN BIORREACTOR

11. Varilla agitadora/impulsor

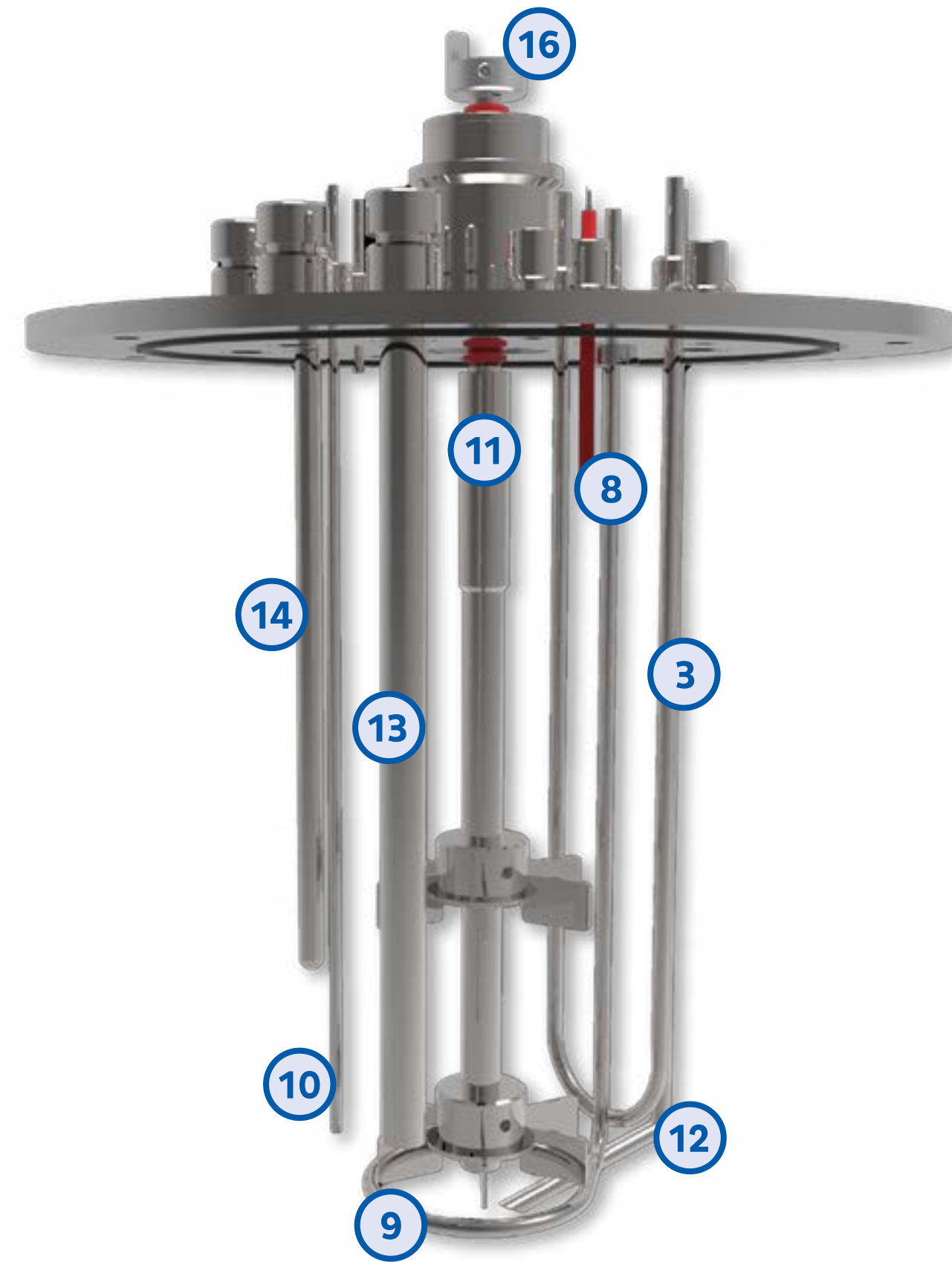
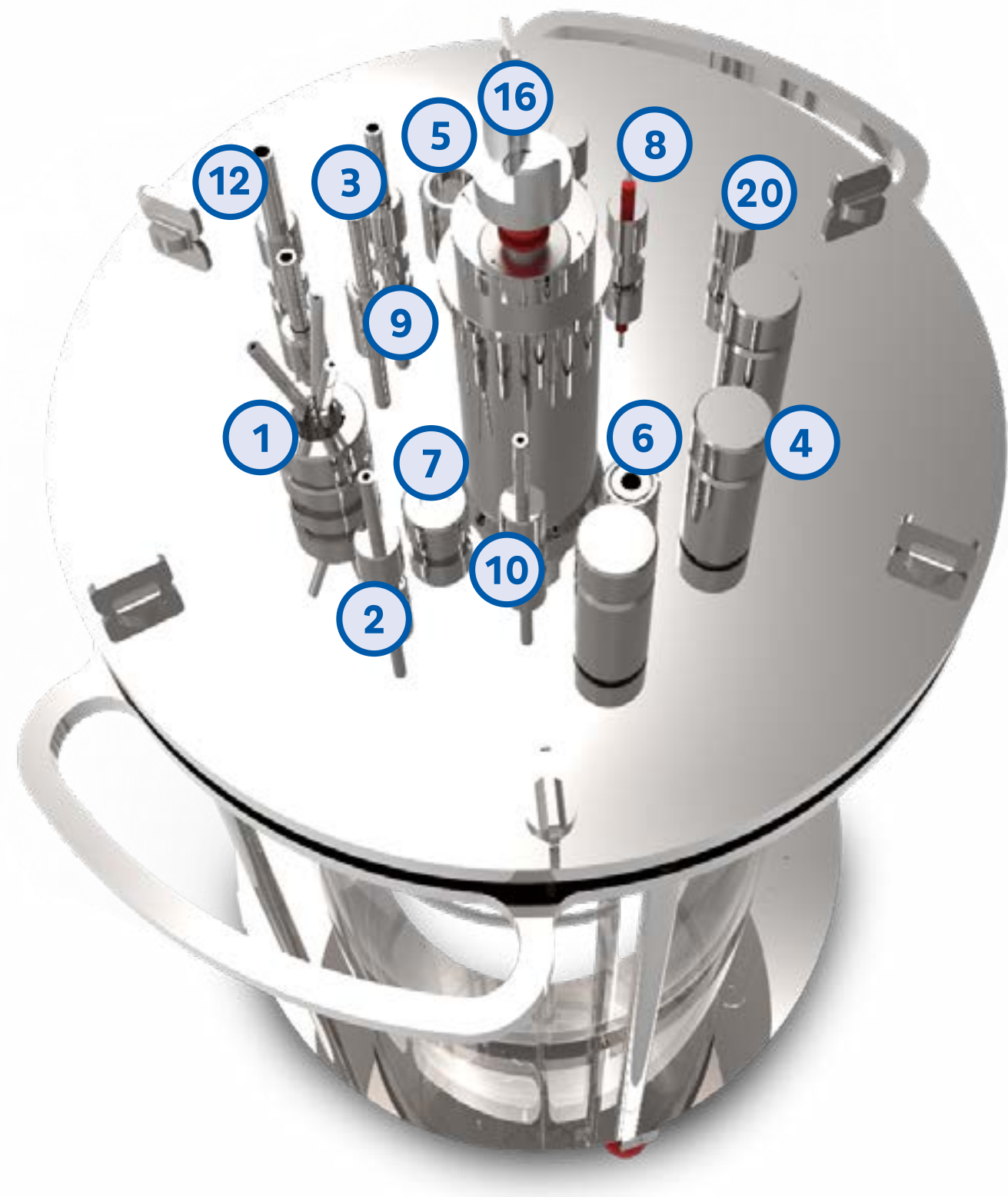

RECURSOS QUE PUEDE OFRECER UN BIORREACTOR

12. Agotador

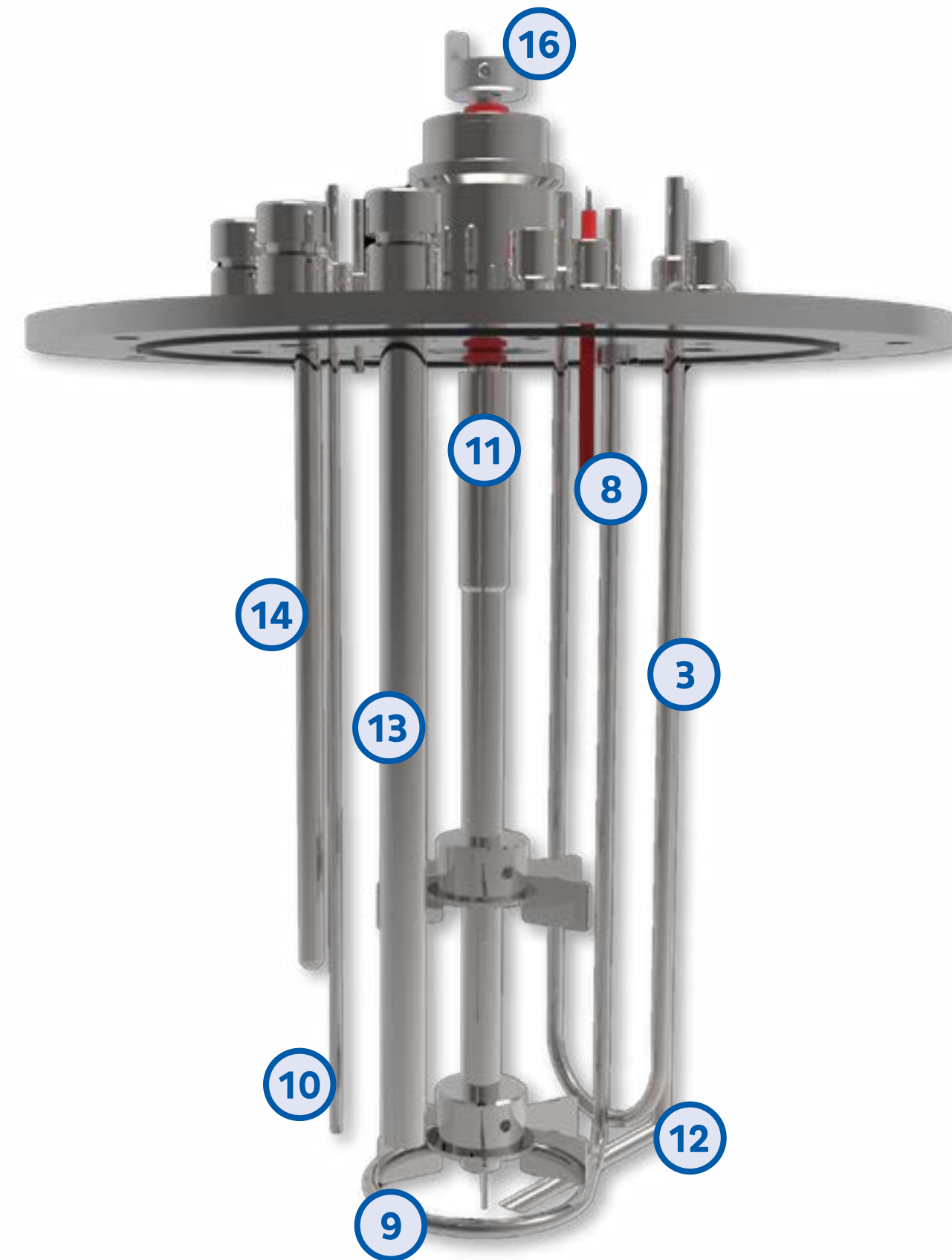
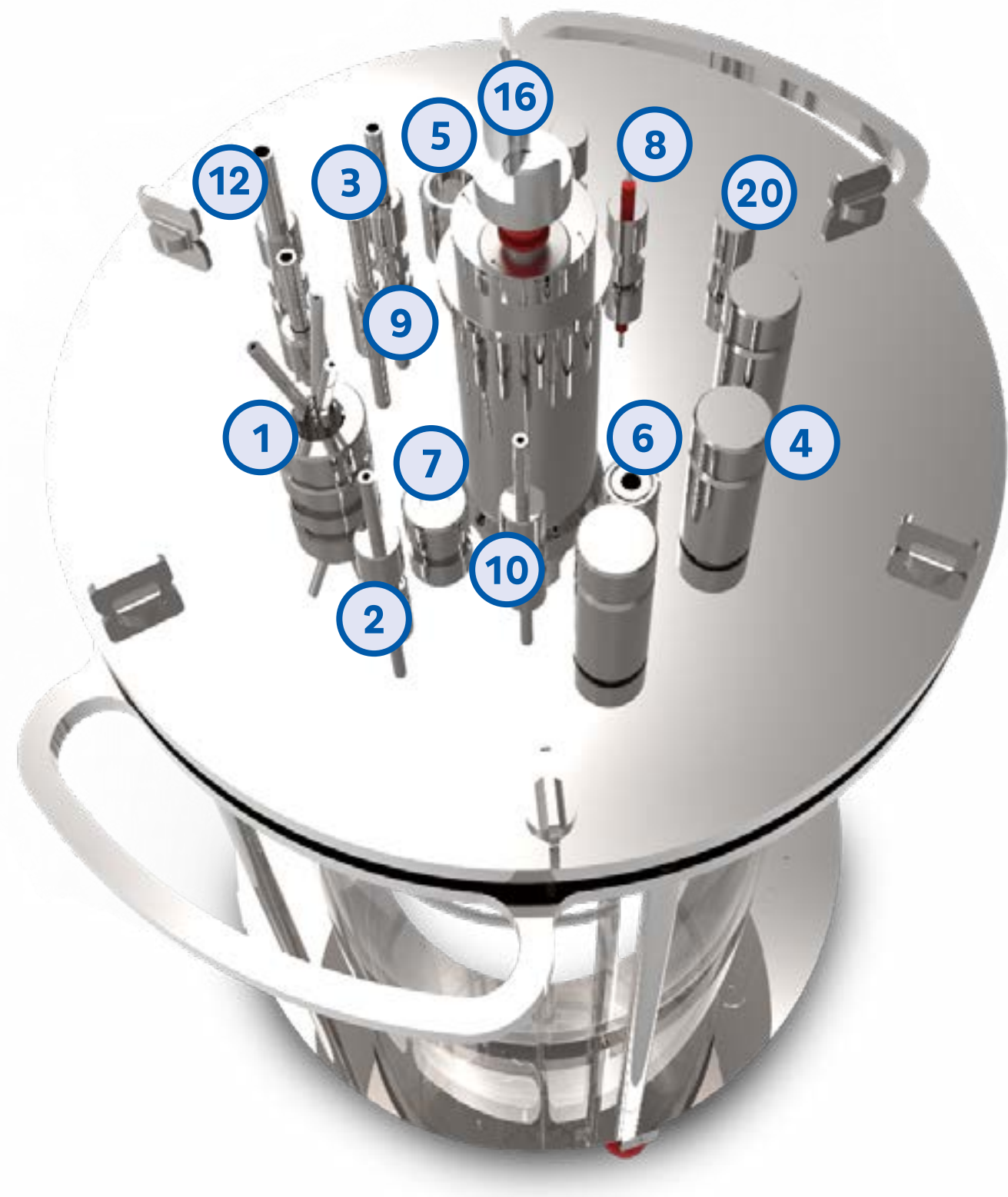

RECURSOS QUE PUEDE OFRECER UN BIORREACTOR

13. Protector para Sensor de pH

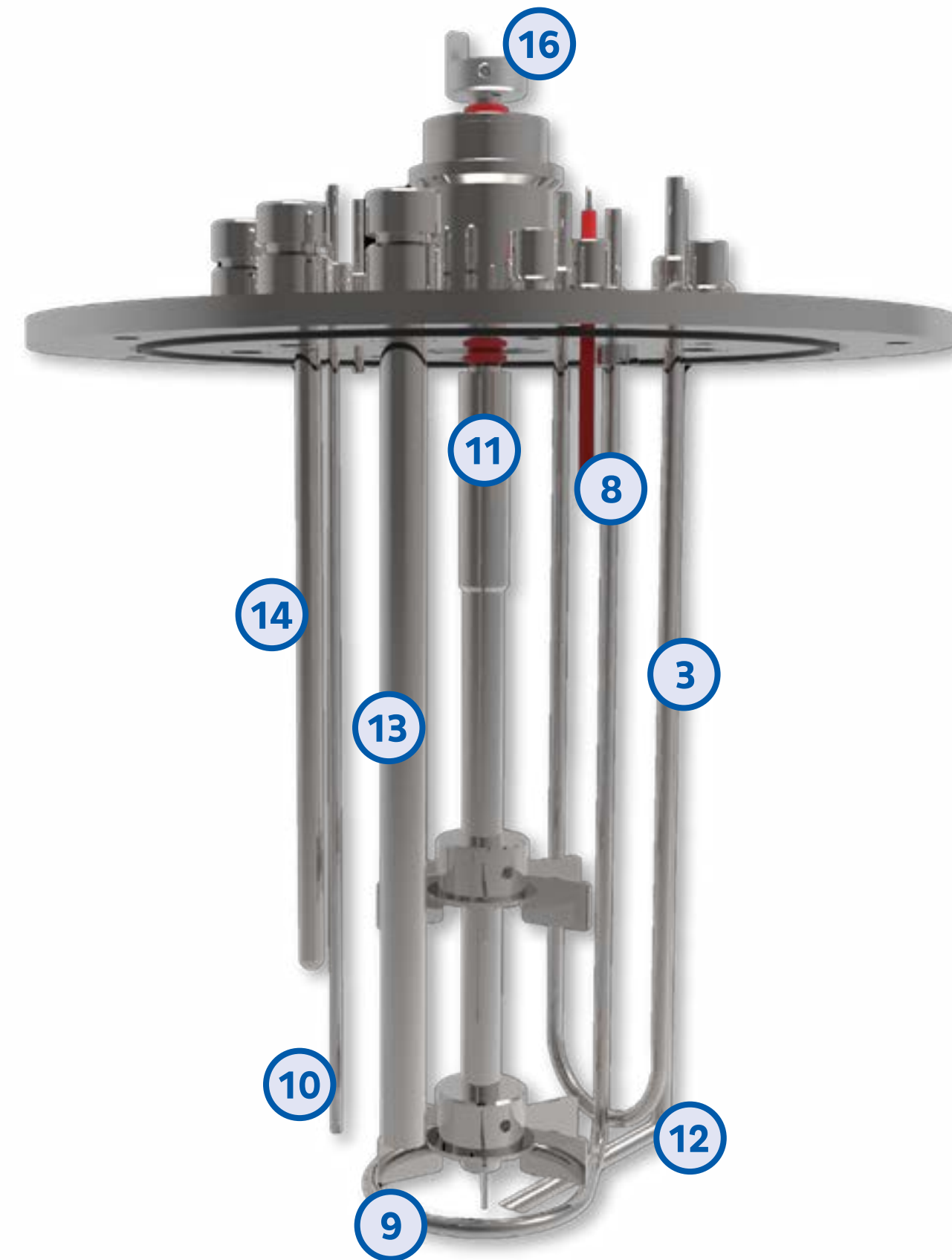
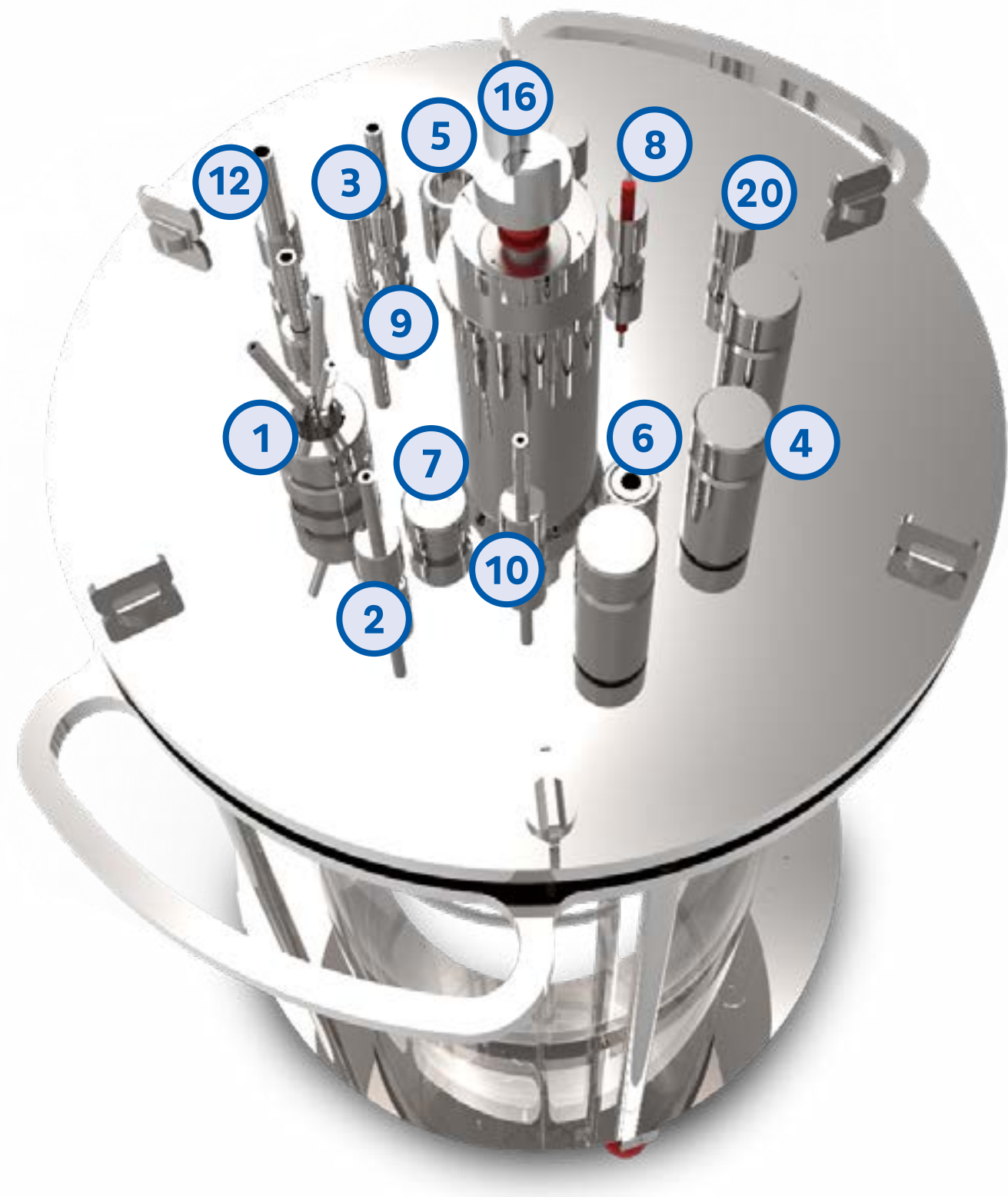

RECURSOS QUE PUEDE OFRECER UN BIORREACTOR

14. Sensor de temperatura

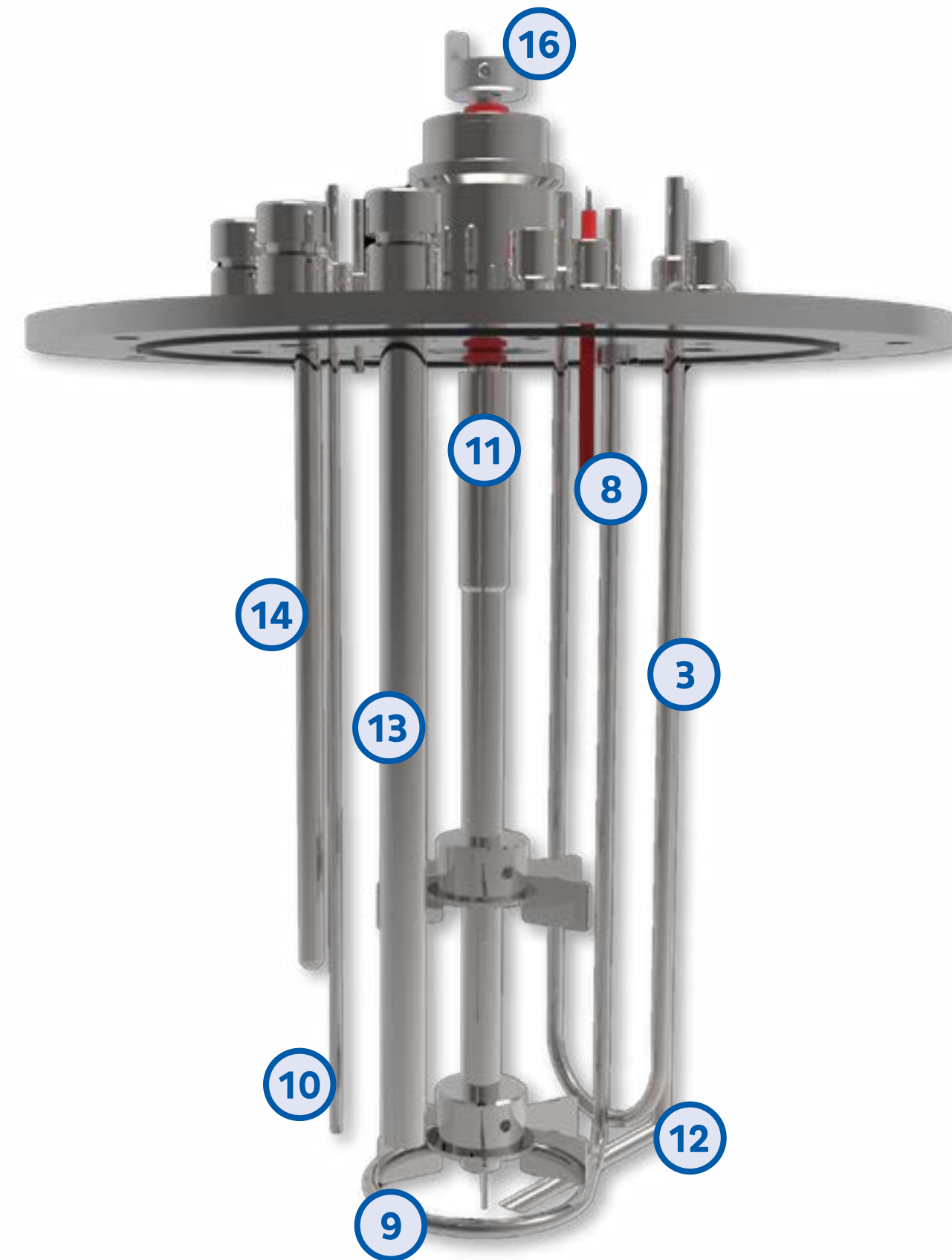
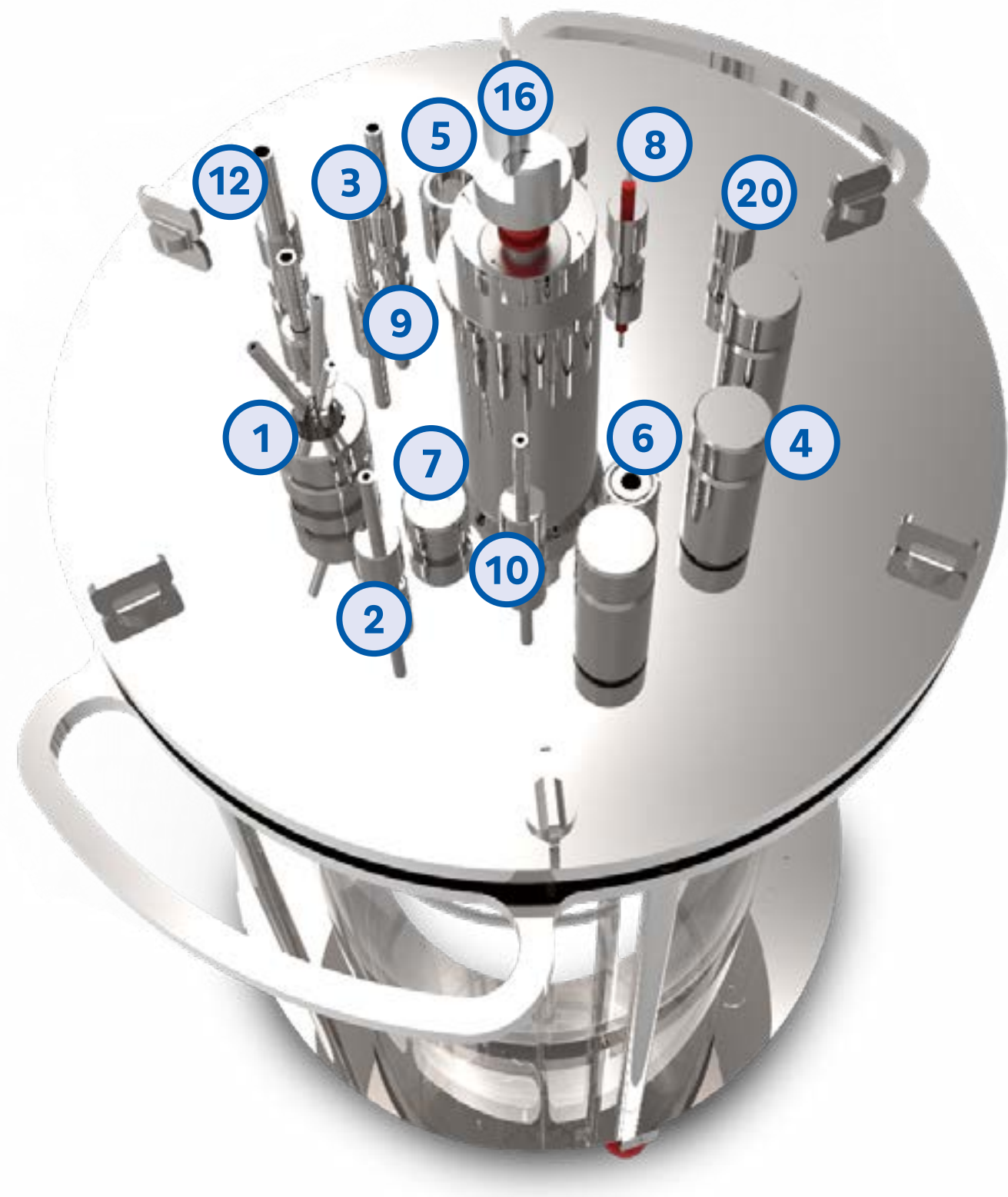

RECURSOS QUE PUEDE OFRECER UN BIORREACTOR

15. Monitor IHM

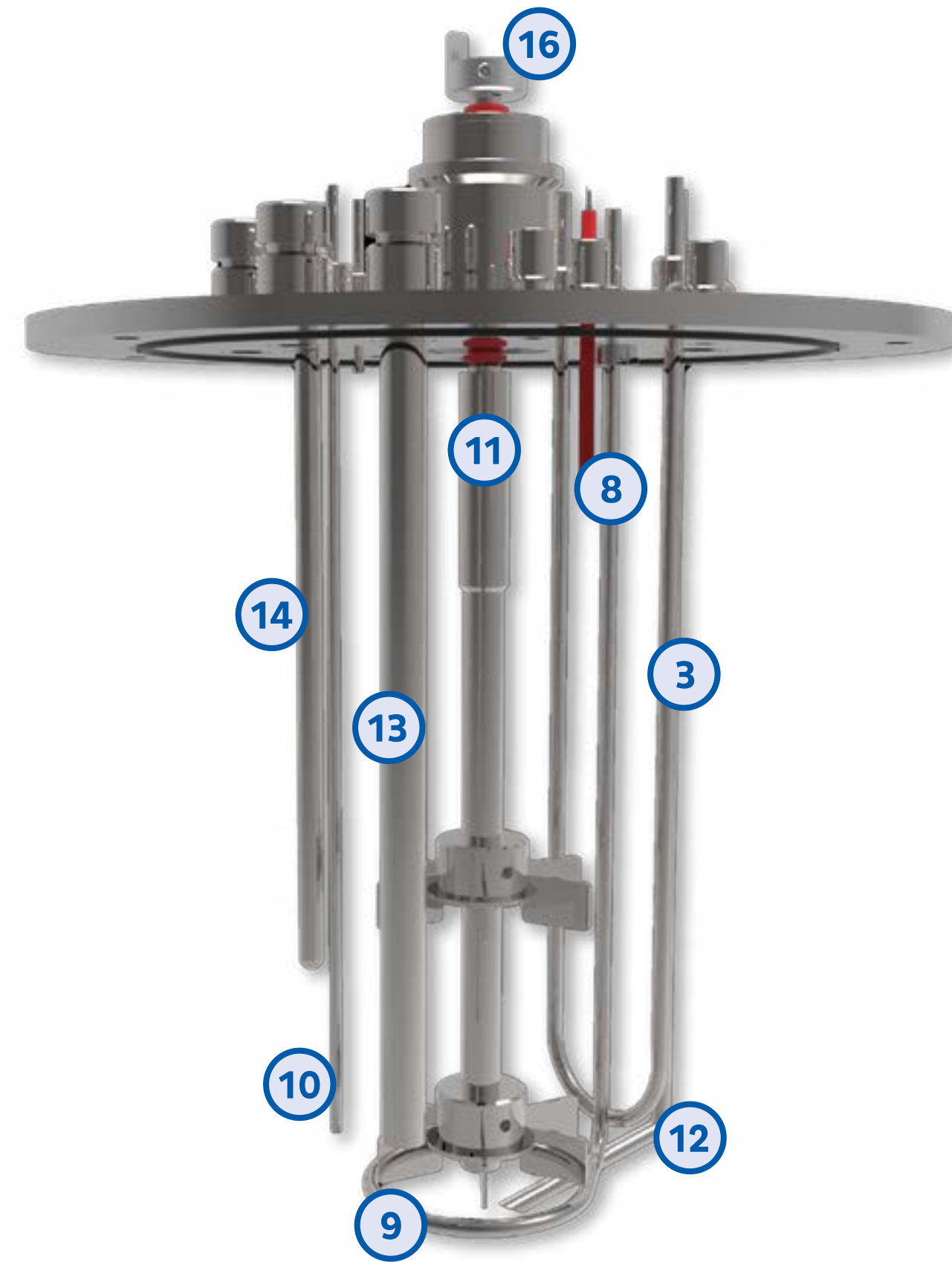
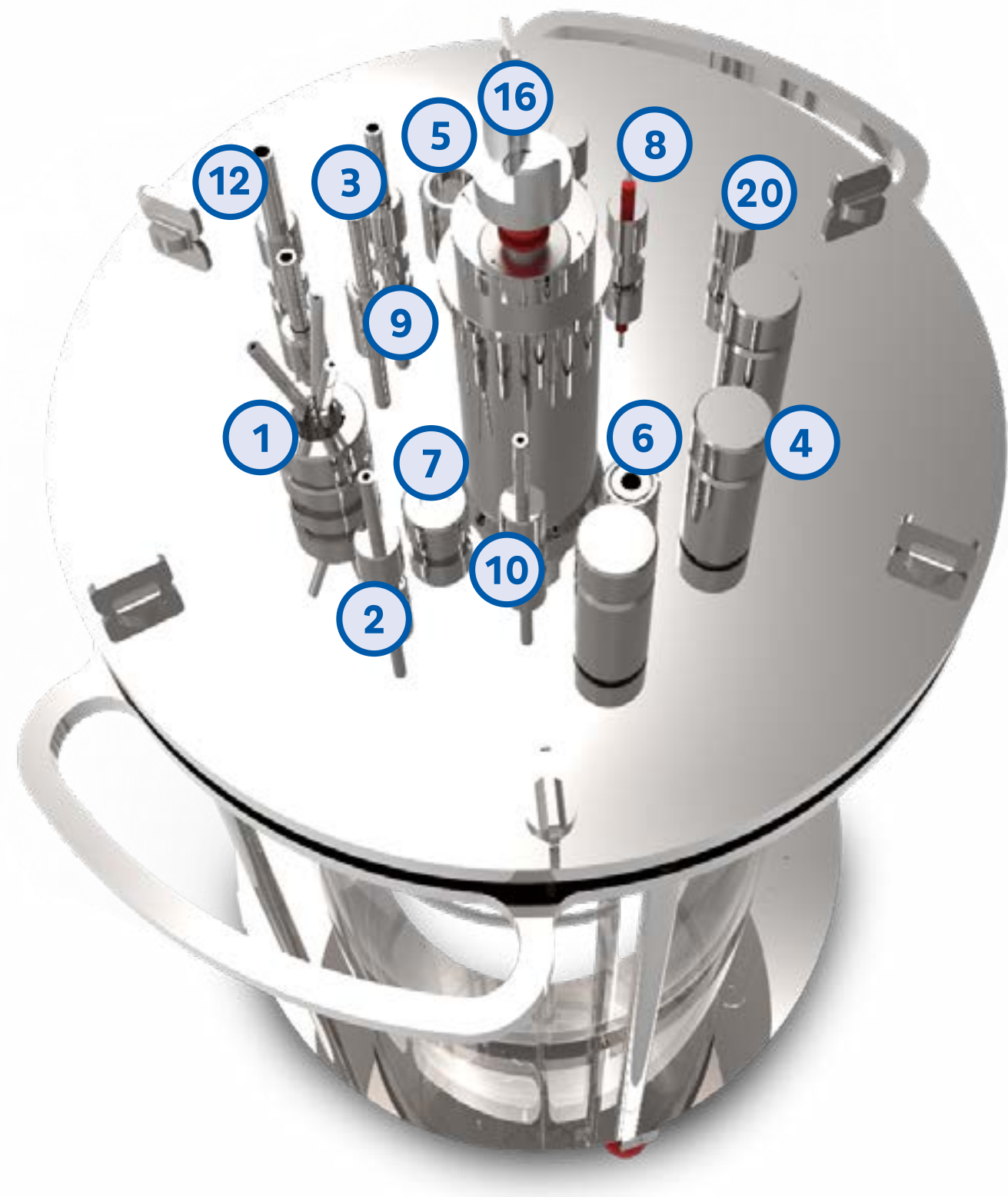

RECURSOS QUE PUEDE OFRECER UN BIORREACTOR

16. Acoplamiento del motor

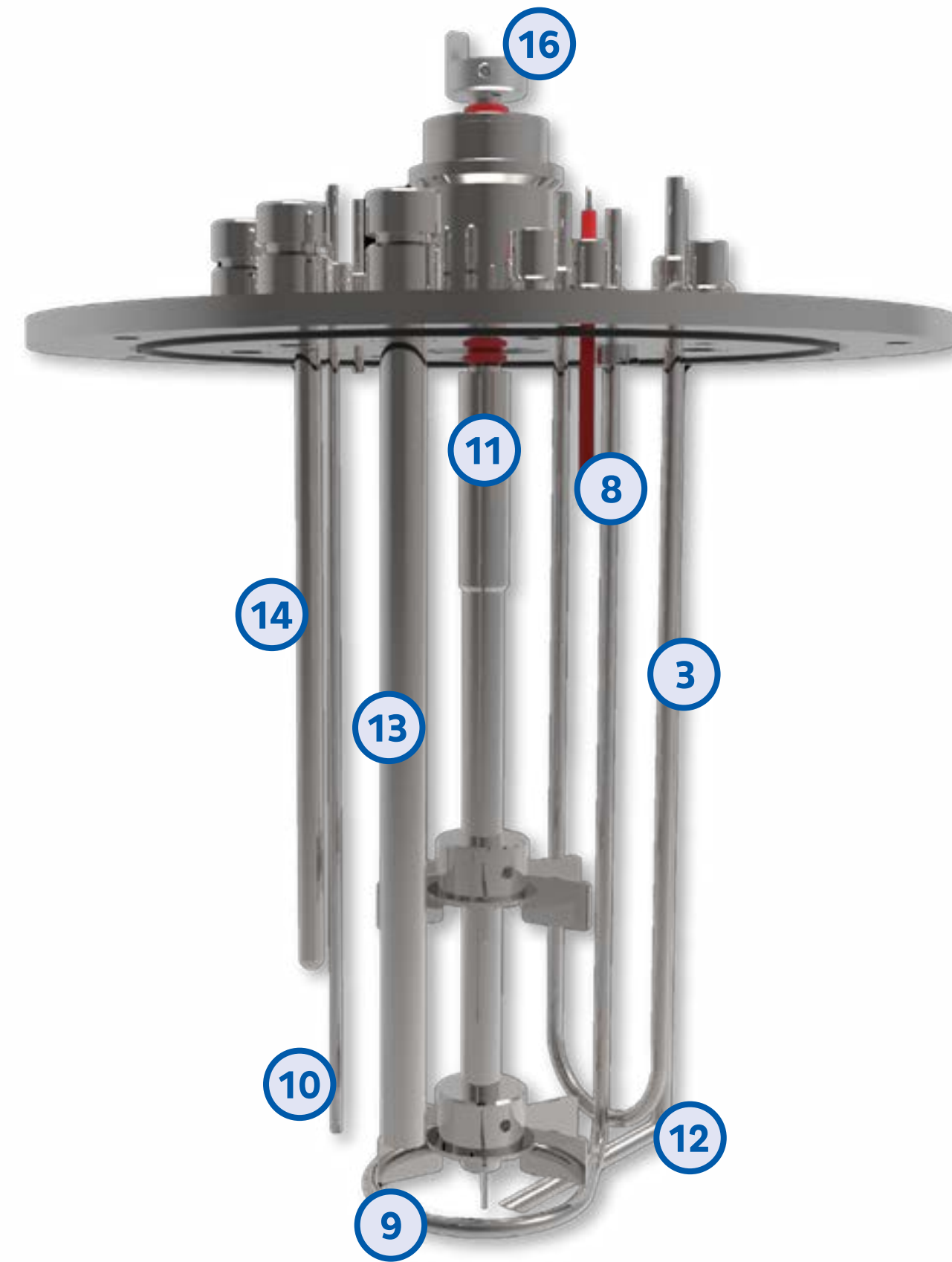
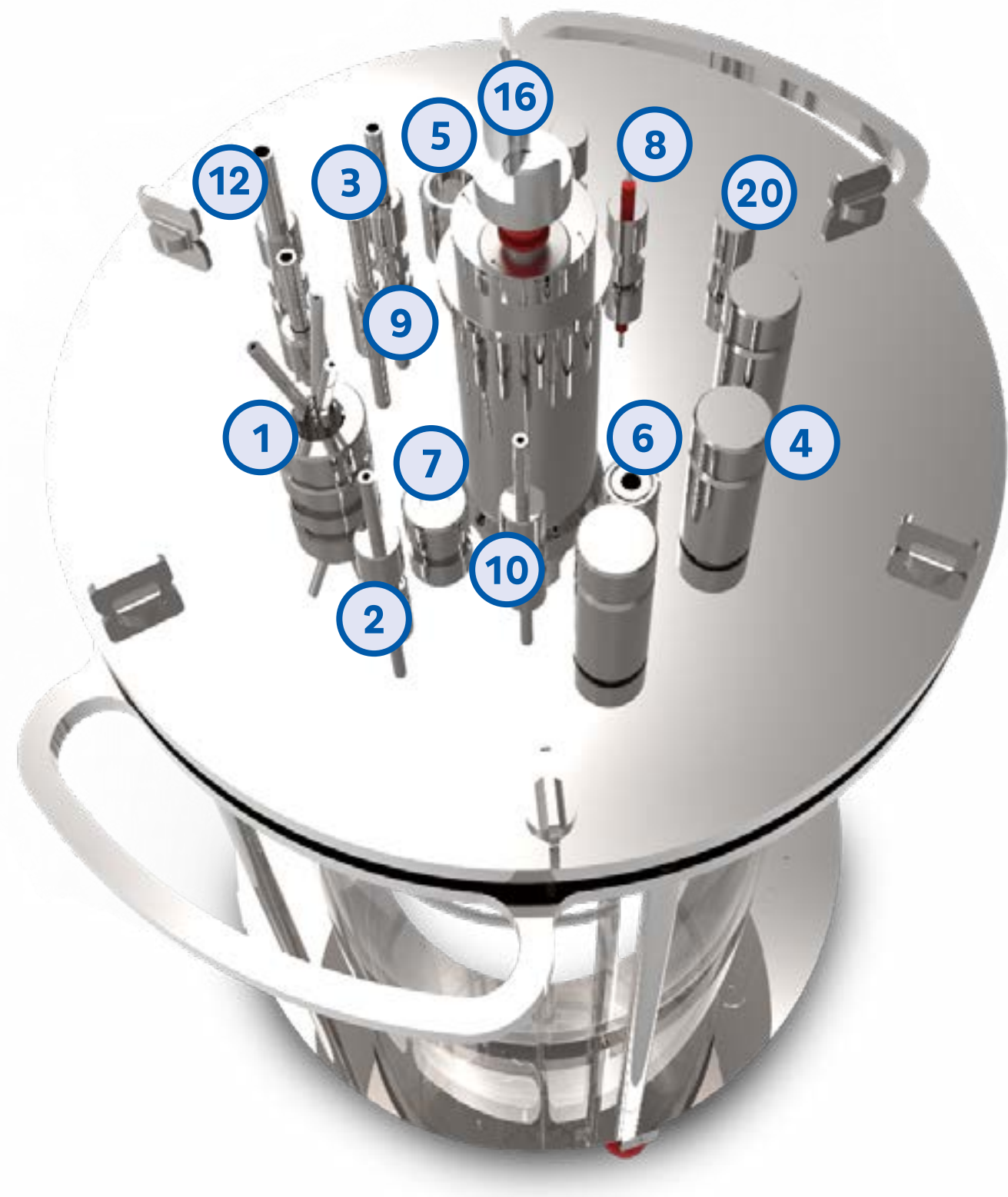

RECURSOS QUE PUEDE OFRECER UN BIORREACTOR

17. Torre de control

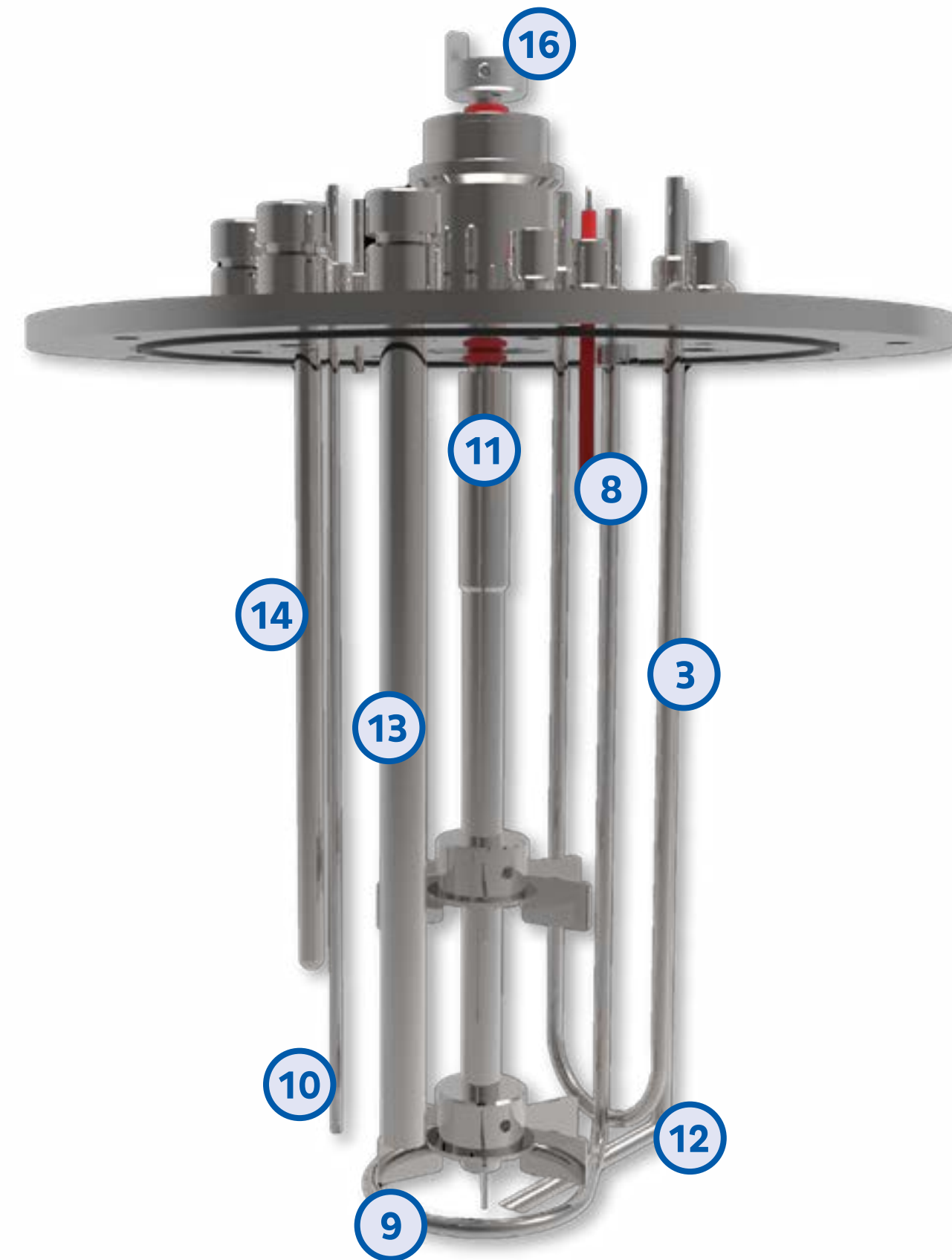
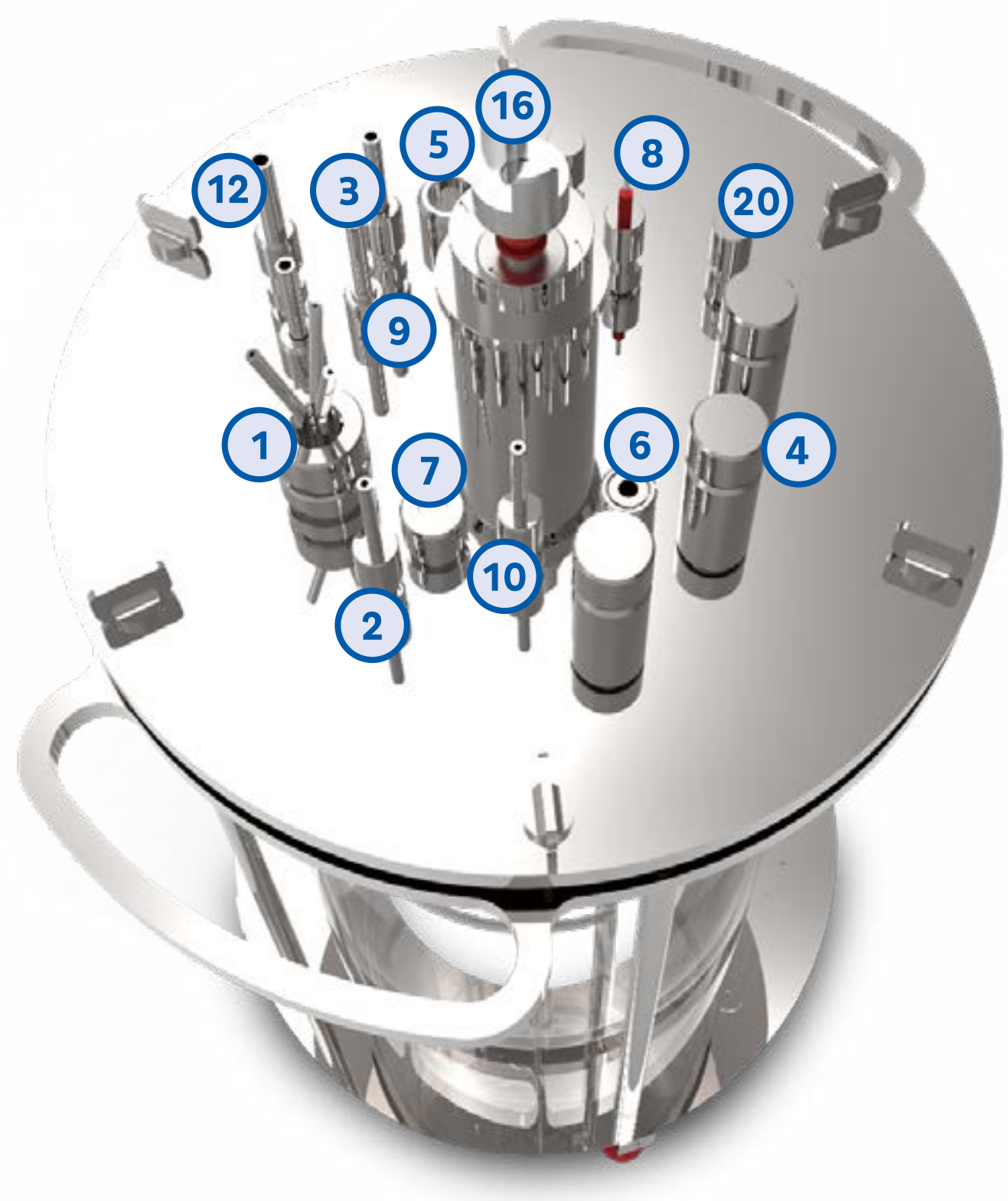

RECURSOS QUE PUEDE OFRECER UN BIORREACTOR

18. Entrada USB

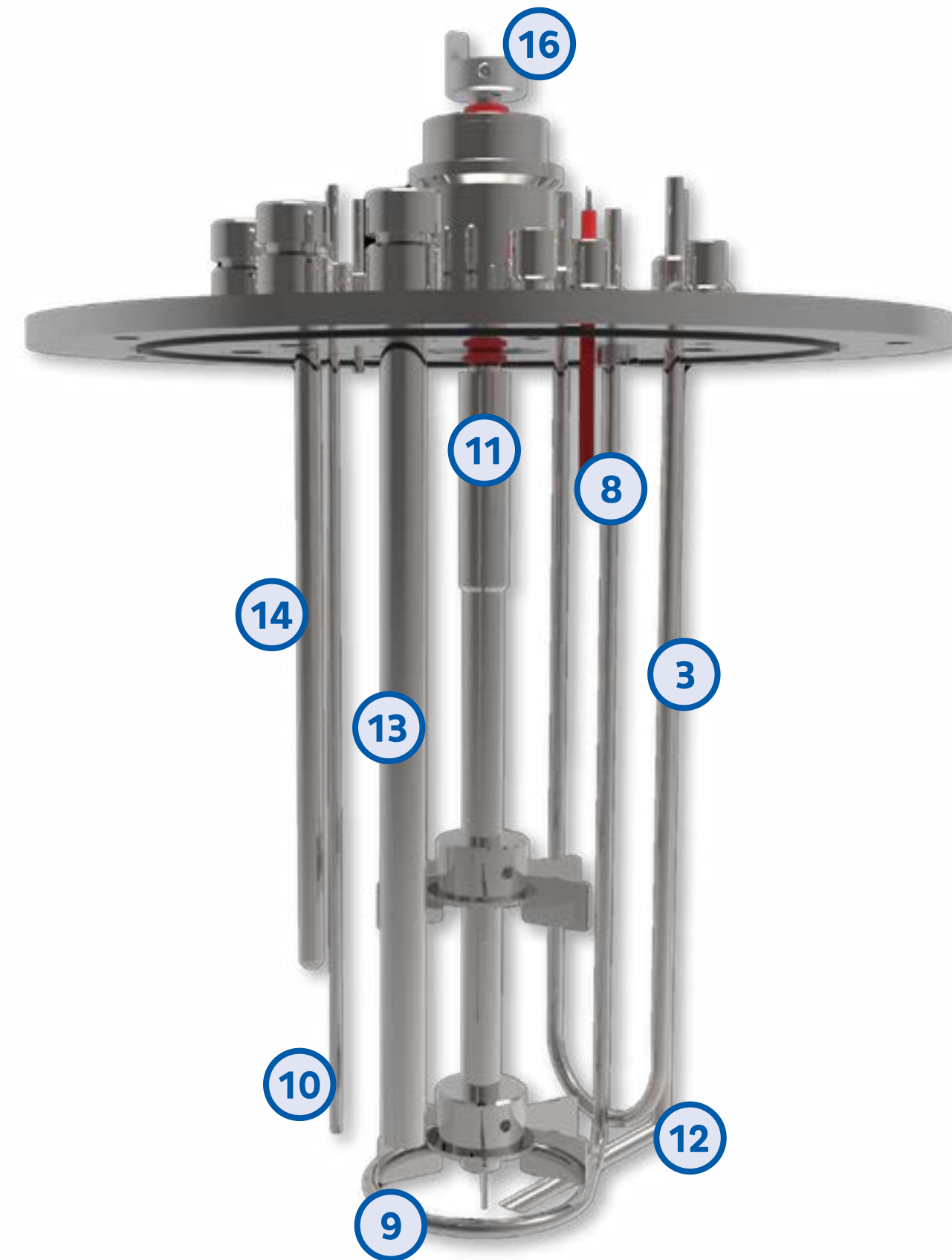
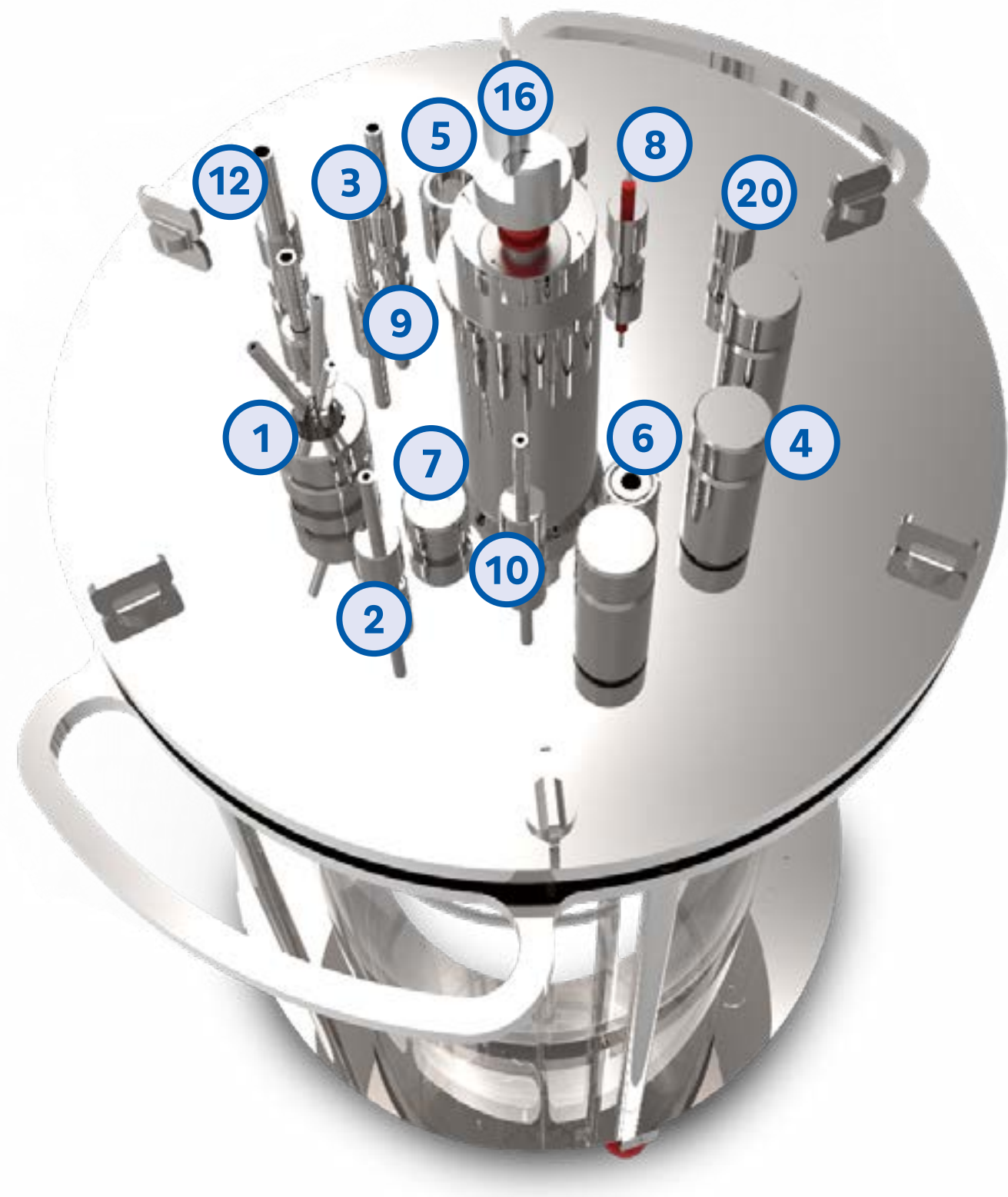

RECURSOS QUE PUEDE OFRECER UN BIORREACTOR

19. Bombas peristálticas

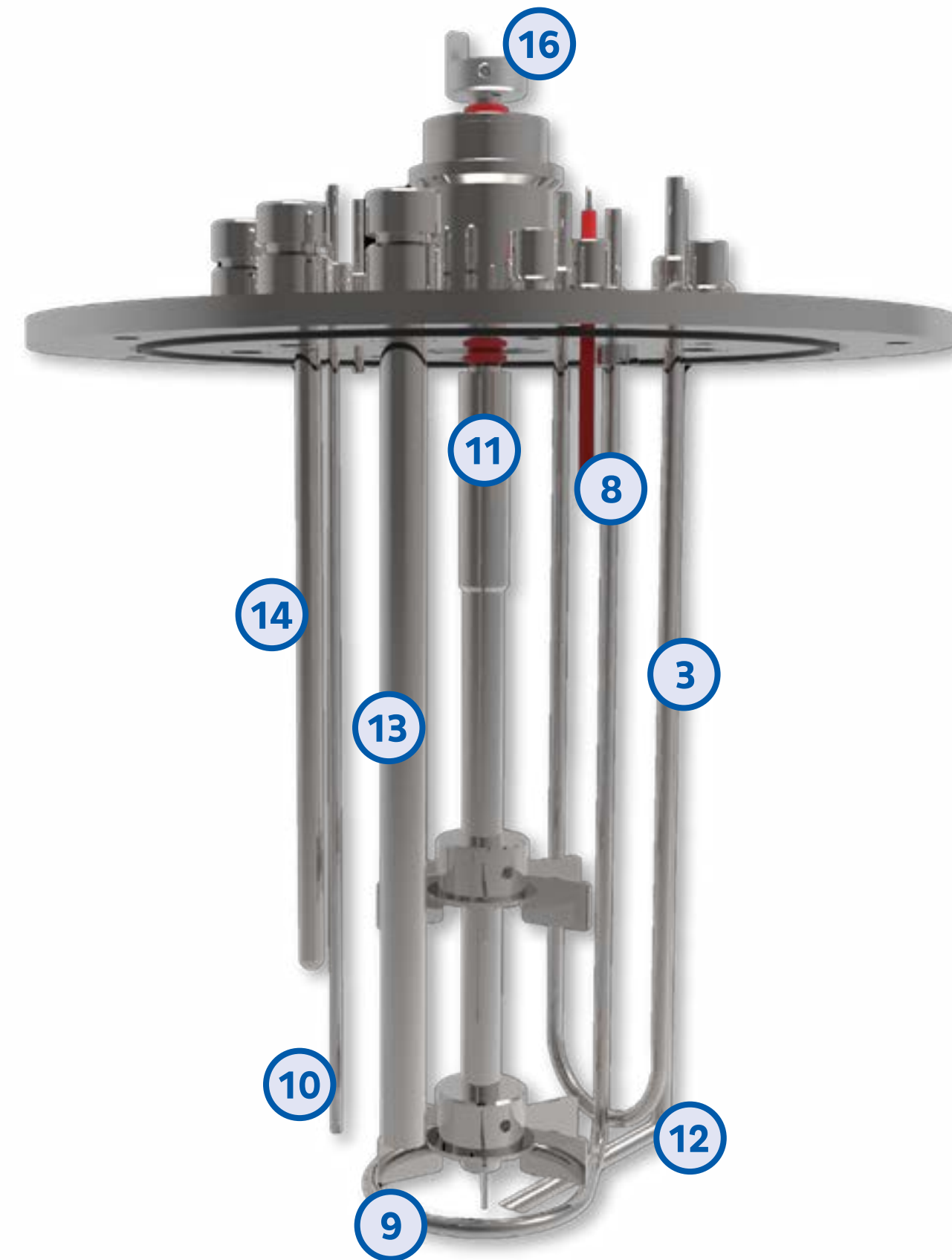
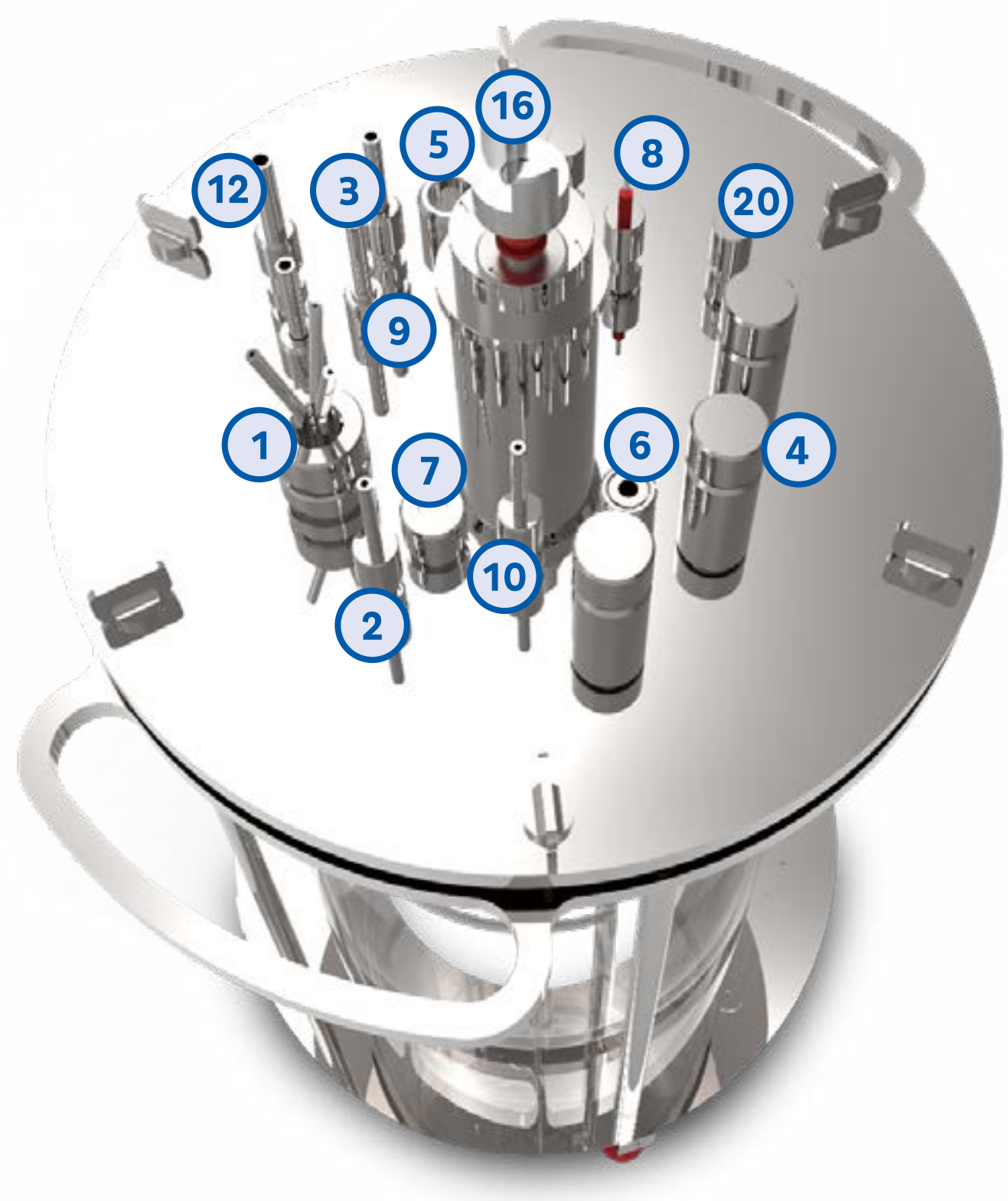

RECURSOS QUE PUEDE OFRECER UN BIORREACTOR

20. Puertas extras

